

OUTDOOR LUMINARIES

OUTDOOR LUMINARIES

LUZ&COLOR 2000

PROYECTOR IRIS



CÓDIGO	W	Lumen	K	CRI	APERTURA
LC-70000-PB-0-30	39	4900	3000	>85	17°/30°/70°
LC-70001-PB-0-30	51	6400	3000	>85	30°/70°



ACCESORIOS:

REF. AC-245 :
ÓPTICA 17°

REF. AC-246 :
ÓPTICA 30°

REF. AC-247 :
ÓPTICA 70°

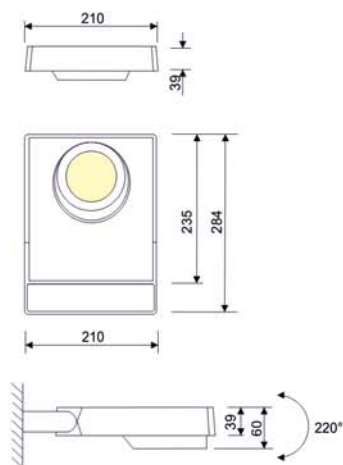

CUSTOMMADE REG

OUTDOOR LUMINARIES

LUZ&COLOR 2000

PROYECTOR SAY

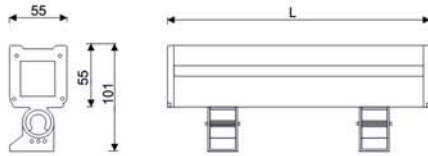

CÓDIGO	W	Lumen	K	CRI	LONGITUD(mm)
LC-70005-PB-0-27	48	6560	2700	>80	1160
LC-70005-PB-0-30	48	6940	3000	>80	1160
LC-70005-PB-0-40	48	7240	4000	>80	1160
LC-70010-PB-0-27	24	3280	2700	>80	600
LC-70010-PB-0-30	24	3470	3000	>80	600
LC-70010-PB-0-40	24	3620	4000	>80	600
LC-70015-PB-0-27	12	1640	2700	>80	320
LC-70015-PB-0-30	12	1730	3000	>80	320
LC-70015-PB-0-40	12	1810	4000	>80	320

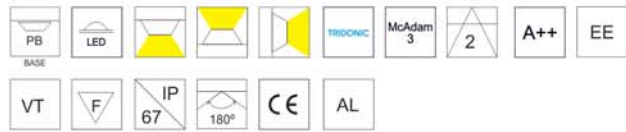

COLORES
02

ACCESORIOS:

REF. AC-248 :
ÓPTICA 60°

REF. AC-249 :
ÓPTICA 90°

OUTDOOR LUMINARIES

LUZ&COLOR 2000

MINISPOT-25 SUELO



CÓDIGO	W	Lumen	K	CRI
LC-70020-DE-0-27	2,5	300	2700	>90
LC-70020-DE-0-30	2,5	311	3000	>90
LC-70020-DE-0-40	2,5	321	4000	>90



ACCESORIOS:

REF. AC-237 :
ÓPTICA 15°

REF. AC-238 :
ÓPTICA 30°

REF. AC-250 :
CAJA DE EMPOTRAMIENTO

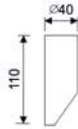
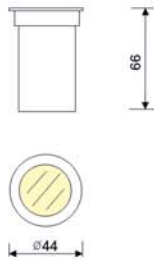

CUSTOMMADE   

OUTDOOR LUMINARIES

MINISPOT-25 BASE



CÓDIGO	W	Lumen	K	CRI
--------	---	-------	---	-----

LC-70023-PB-0-27	2,5	300	2700	>90
LC-70023-PB-0-30	2,5	311	3000	>90
LC-70023-PB-0-40	2,5	321	4000	>90

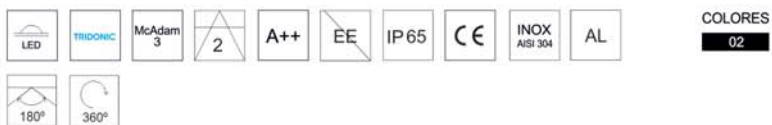

ACCESORIOS:

REF. AC-237 :
ÓPTICA 15°

REF. AC-238 :
ÓPTICA 30°

REF. AC-441
PINCHO JARDIN

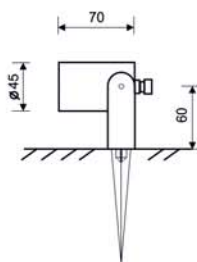

OUTDOOR LUMINARIES

LUZ&COLOR 2000

MINISPOT-35 SUELO



CÓDIGO	W	Lumen	K	CRI
--------	---	-------	---	-----

LC-70021-DE-0-27	8	926	2700	>90
LC-70021-DE-0-30	8	976	3000	>90
LC-70021-DE-0-40	8	1076	4000	>90



ACCESORIOS:

REF. AC-240 :
ÓPTICA 15°

REF. AC-239 :
ÓPTICA 30°

REF. AC-250 :
CAJA DE EMPOTRAMIENTO

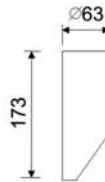
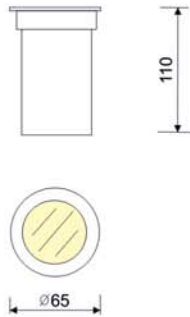

OUTDOOR LUMINARIES

MINISPOT-35 BASE

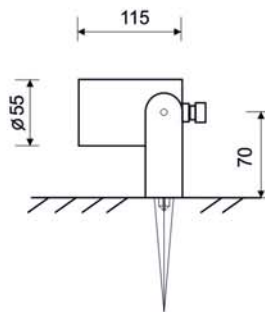

CÓDIGO	W	Lumen	K	CRI
LC-70024-PB-0-27	8	926	2700	>90
LC-70024-PB-0-30	8	976	3000	>90
LC-70024-PB-0-30	8	1076	4000	>90

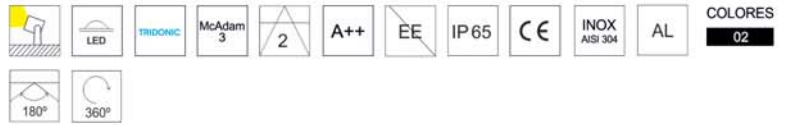

ACCESORIOS:

REF. AC-237 :

ÓPTICA 15°

REF. AC-238 :

ÓPTICA 30°

REF. AC-441 :

PINCHO JARDIN



OUTDOOR LUMINARIES

LUZ&COLOR 2000

WINTER SUELO 12W

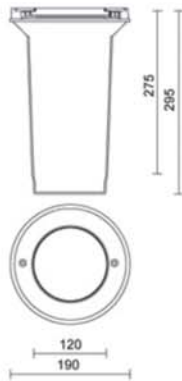

CÓDIGO	W	Lumen	K	CRI
LC-70022-DE-0-30	12	1800	3000	>85



ACCESORIOS:

REF. 99995-2 :
ÓPTICA 15°

REF. 99995-3 :
ÓPTICA 30°

REF. 99995-4 :
ÓPTICA 30°

CAJA DE EMPOTRAMIENTO



OUTDOOR LUMINARIES

LUZ&COLOR 2000

EMPOTRADO PARED

FREE-1

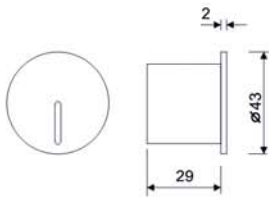
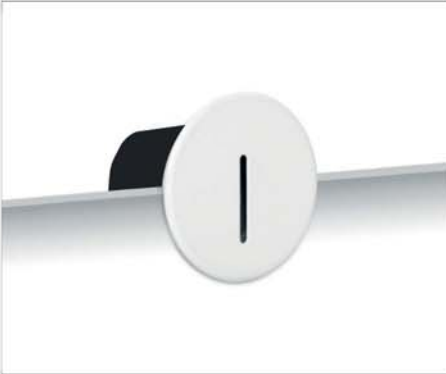

CÓDIGO	W	Lumen	K	CRI
LC-51150-SD-0-27	3	362	2700	>90
LC-51150-SD-0-30	3	374	3000	>90



COLORES



FREE-2

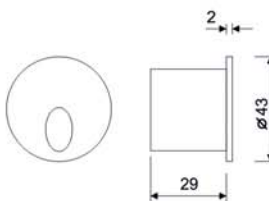

CÓDIGO	W	Lumen	K	CRI
LC-51151-SD-0-27	3	362	2700	>90
LC-51151-SD-0-30	3	374	3000	>90



COLORES

