

LIGHTING PROJECTS

LIGHTING DESIGN

LED TECNOLOGY



One solution for each project

CUSTOMMADE

 ACABADOS



 POTENCIAS

 2700°K 3000°K 4000°K 5000°K 6500°K

 REGULACIÓN DALI, PUSH-DIM, 1-10V...

 LONGITUDES

 **LEDS PARA APLICACIONES ESPECIALES:**  ALIMENTACIÓN

 RETAIL

 JOYERÍA

 ARTE Y CULTURA

Special LIGHTING for each application

DESTACA LAS MEJORES CUALIDADES DE LOS PRODUCTOS

AYUDA A MEJORAR LA AFLUENCIA DE CLIENTES

RESALTA EL PRODUCTO

REFUERZA LAS LABORES DE PROMOCIÓN Ó MARKETING

CAPTACIÓN MÁS EFICAZ

AYUDA A QUE SU TIENDA SEDUZCA A LOS CLIENTES

COLORES ESPECÍFICOS
PARA UNA SUGERENTE PRESENTACIÓN DE LOS ARTÍCULOS

EN ALIMENTOS FRESCOS NO DAÑA EL PRODUCTO



ALIMENTACIÓN



CARNICERÍAS CARNES ROJAS



PICTO

CR

Las carnes frescas tienen un color rojo saturado bajo esta luz. Incluso los hilos blancos aparecen rojo. Un impulso de rojo para el mostrador de carne.

CARNICERÍAS CARNES BLANCAS



PICTO

CB

El color de la luz perfecta para carnes blancas, rosadas y embutidos. Los hilos blancos de la carne no se destacan por este color de la luz, pero el rojo de la carne se ve muy apetitoso.

PANADERÍAS



PICTO

PN

Este producto emite una luz cálida y brillante. Este color de la luz es ideal para productos de panadería.

BOLLERÍAS



PICTO

RP

Este producto emite una luz con un tinte de color marrón para dar una apariencia recién salido del horno.

PESCADERÍAS



PICTO

PS

Este producto emite una luz blanca fría que reflejada en el hielo da sensación de recién pescado.

QUESERÍAS



PICTO

QU

Los tonos amarillos de luz atraen la atención de los clientes, despiertan su apetito y les anima a comprar.

VERDULERÍAS



PICTO

VR

Este producto acentúa el frescor de la verdura.

FRUTERÍAS



PICTO

FR

Este producto acentúa las tonalidades rojas y anaranjadas para realzar las frutas tales como manzanas o naranjas.

LEDS ESPECIALES

LUZ&COLOR 2000



RETAIL



PICTO

RT

Este producto consigue colores cálidos penetrantes con una elevada saturación, combinados con un blanco claro y radiante. Haga que los colores de las prendas sean vivos y penetrantes.



JOYERÍA



PICTO

JY

Este producto emite una luz cálida y brillante especial para artículos de joyería.



ARTE - CULTURA



PICTO

AR

Este producto consigue la calidad lumínica exigida para la exposición de objetos valiosos debido a su excelente reproducción de color CRI 98 en consonancia con su elevada consistencia de color (MacAdam 2)

ILUMINACIÓN LED



Luz y Color incorpora leds de última generación con unas altas prestaciones.

Elevada reproducción cromática **CRI95**

Temperaturas de color **flexibles**

Alta eficiencia luminosa hasta 150lm/W a la temperatura de funcionamiento del led

Elevada consistencia de color (**McAdm 3**) no hay diferencias de color entre diferentes partidas del led

5

AÑOS DE GARANTÍA

Ejemplo Referencia



FAMILIA

DE	LUMINARIAS EMPOTRADAS
PC	PROYECTORES EN CARRIL
PB	PROYECTORES EN BASE DE PARED O TECHO
SA	SISTEMAS AÉREOS
SD	LUMINARIAS DE SUPERFICIE

SUBFAMILIA

0	MODELO NO REGULABLE
E	MODELO CON EMERGENCIA
B	MODELO REGULABLE BLUETOOTH
D	MODELO REGULABLE DALI
W	MODELO REGULABLE WIFI
F	MODELO REGULABLE CORTE DE FASE
P	MODELO REGULABLE PULSADOR
V	MODELO REGULABLE 1-10V
1	MODELO CON EMERGENCIA Y REGULABLE
S	MODELO DE FABRICACIÓN ESPECIAL



































TIPOS DE LED

27	LED CON TEMPERATURA DE COLOR 2700°K
30	LED CON TEMPERATURA DE COLOR 3000°K
40	LED CON TEMPERATURA DE COLOR 4000°K
CR	LED ESPECIAL CARNES ROJA
CB	LED ESPECIAL CARNES BLANCAS
PN	LED ESPECIAL PANADERÍA
RP	LED ESPECIAL PASTELERÍA-BOLLERÍA
PS	LED ESPECIAL PESCADERÍA
QU	LED ESPECIAL QUESERÍAS
FR	LED ESPECIAL FRUTERÍA
VE	LED ESPECIAL VERDULERÍA
AR	LED ESPECIAL ARTE Y CULTURA
JY	LED ESPECIAL JOYERÍA
RT	LED ESPECIAL RETAIL







ALIMENTACIÓN

COLOR

01	LACADO BLANCO	T1	TEXTURADO BLANCO
02	LACADO NEGRO	T2	TEXTURADO NEGRO
03	ORO PULIDO		
04	CROMADO BRILLO		
05	ANODIZADO PLATA		
06	ANODIZADO NEGRO		
07	LACADO GRIS	T7	TEXTURADO GRIS
08	LACADO ORO		
09	ANODIZADO MATE		
10	NIQUEL SATINADO		
11	ALUMINIO NATURAL		
99	ACABADO ESPECIAL (ROJO,AZUL,VERDE...)		

	Modelo empotrable		VT Vidrio templado
	Modelo superficie-techo		DP Difusor material plástico
	Modelo superficie-pared		CE Conforme a las directrices europeas
	Modelo suspendido		MR 16 Lámpara Led MR16
	Permite montaje en linea continua		AR-111 Lámpara Led AR111
	Clase I - Luminaria provista con toma a tierra		GU10 Lámpara Led GU10
	Clase II - Doble aislamiento		PAR-20 Lámpara Led E27-Par20
	Clase III - Bajo Voltage		E27 Lámpara Led E27
	Aparato para superficies inflamables		LED Modelo con tecnología Led
	Modelo a carril electrificado		TRIDONIC Led primera marca Tridonic
	Modelo con base a Techo-Pared		McAdam 3 Consistencia de color en el Led
	Equipo electrónico incluido		A++ Eficiencia energética del Led
	Indice de deslumbramiento unificado		
	Grado de protección IP		
	Ángulo de apantallamiento		
	Corte de techo cuadrado		
	Corte de techo redondo		
	Altura de empotramiento		
	Curva fotométrica según lámpara		
	Curva fotométrica L&C2000		
	Ángulo máximo de giro vertical		
	Ángulo máximo de giro horizontal		
	Regulación en altura		
	Fabricado en aluminio		

CUSTOMMADE

	Led especial bajo pedido
	Acabados especiales bajo pedido
	Cambio de potencias bajo pedido
	°K Temperatura de color (°K) bajo pedido
	REG Regulación del modelo bajo pedido
	Medidas especiales bajo pedido

RECESSED SYSTEMS



Crom Trimless
Página:16

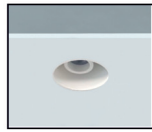

BK Round
Página:17



BK Square Simple
Página:18



BK Square Simple
Página:18

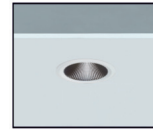

Serie Ada1
Página:19

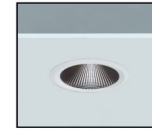

Serie Ada 2
Página:19



Serie Ada 3
Página:20



Deko 1
Página:21

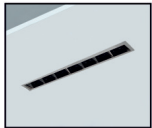

Deko 2
Página:21



Tech 58
Página:22



Tech 85
Página:22



C1
Página:23



C2
Página:23



Lotse
Página:24



Serie Block 128
Página:26



Serie Block 128
Página:27



Mini-Block Simple
Página:28



Mini-Block Doble
Página:28



Line Block
Página:29



Gauss Simple
Página:31



Gauss Doble
Página:31

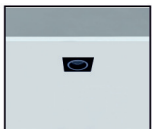

Gauss Trimless
Página:32

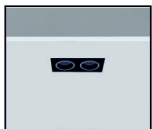

Gauss Trimless
Página:32



Serie Fly-c 220
Página:33



Serie Fly-c 140
Página:33

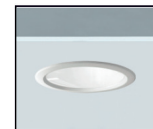

Serie Fly 230
Página:34

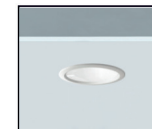

Serie Fly 140
Página:34



Serie Fort 134
Página:35



Serie Fort 180
Página:35

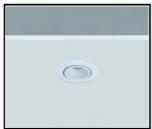

Lesor 50
Página:36

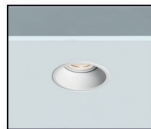

Lesor 60
Página:36

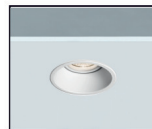

Lesor 80
Página:37

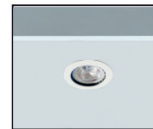

Tau
Página:38



Lamber 280
Página:39



Lamber 140
Página:39



Pantalla polivalente
Página:40



Pantalla polivalente
Página:40



Panel led
Página:41

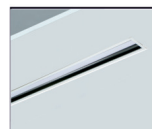

Rus Apantallada
Página:43

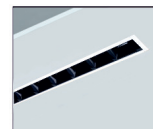

Rus high contrast
Página:44

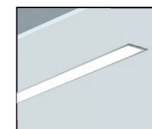

Rus
Página:45

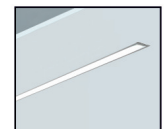

Slim Rus
Página:46



Multi System Rus
Página:48-49

SPOTLIGHTS

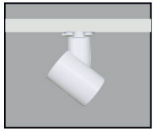

Vitra
Página:51

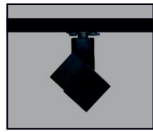

Delta
Página:52

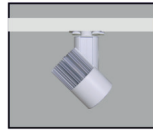

Odeón 85
Página:53



Odeón 120
Página:54

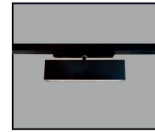

Wallight
Página:55



Rm2 Intrack
Página:56

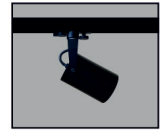

Selene
Página:57



Air 1
Página:58

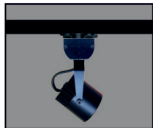

Air 2 Dim
Página:59

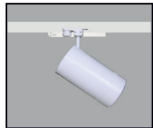

River 120 Intrack
Página:60

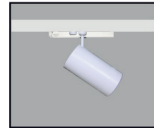

River 90 Intrack
Página:61



K-60
Página:62



Odeón 60 Intrack
Página:62

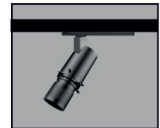

Recorte intrack
Página:63



Zoom 10-60
Página:64

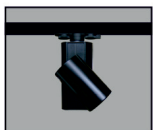

Odeón 60
Página:65

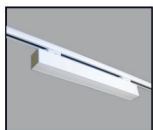

Rus carril
Página:66

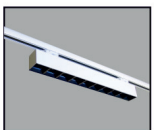

Rus High-Contrast
Página:66

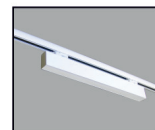

Slim Rus carril
Página:67

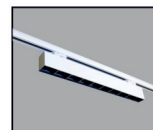

Slim High-Contrast
Página:67

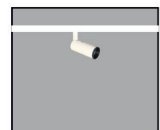

Rm1
Página:69

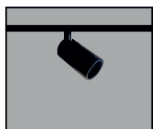

Rm2
Página:69



Rm3
Página:70

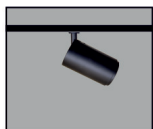

Rm4
Página:70

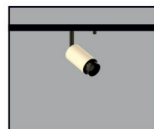

Zoom Rm1
Página:71

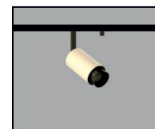

Zoom Rm2
Página:71



Recorte Intrack 48V
Página:72



Line 48V
Página:73



Line Lens 48V
Página:73



Cover 48V
Página:74



Micro 5W
Página:76



Zoomable Micro
Página:76



Recorte Micro
Página:78



Micro Sun
Página:79

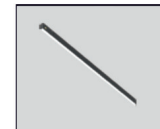

Lineal Micro 24V
Página:80



Micro Lens 24V
Página:80



Micro Tube 24V
Página:82



Micro Suspend
Página:82

SUSPENDED LUMINARIES



Rus
Página:84

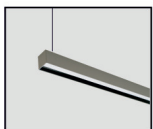

Rus Apantallada
Página:85

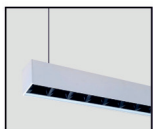

Rus High Contrast
Página:86



Slim Rus
Página:87

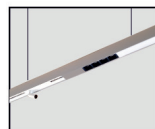

Multi System Rus
Página:88

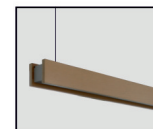

Wooden Rus
Página:91

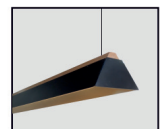

Alpha
Página:94



Beta
Página:94



Cooper 205
Página:95



Cooper 155
Página:96



Mini Cooper
Página:97



Eclipse
Página:98



Block simple
Página:104

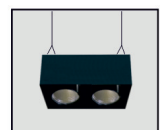

Block Doble
Página:104



Box 135
Página:108



Cilim 120
Página:109



Box 90
Página:110



Cilim 85
Página:111



Cover 120
Página:101



Cover 90
Página:102



Sumer 38
Página:117



Summer 50
Página:117

SURFACE LUMINARIES

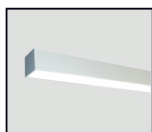

Rus
Página:73

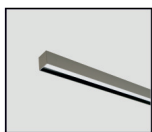

Rus Apantallada
Página:74

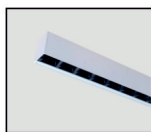

Rus Hight Contrast
Página:75



Slim Rus
Página:76



Multi System Rus
Página:78

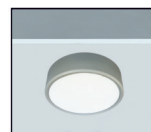

Scala
Página:100

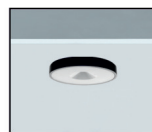

Round
Página:100

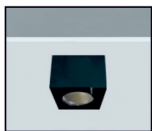

Block Simple
Página:104



Block Doble
Página:104



Bk Square Doble
Página:105



Bk Square Doble
Página:105



Deko 1
Página:106

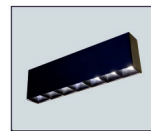

Deko 2
Página:106



Box 135 Luz D/I
Página:108

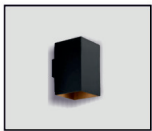

Box 135 Luz Directa
Página:108

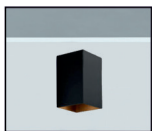

Box 135 Techo
Página:108



Box 90 Luz D/I
Página:110



Box 90 Luz Directa
Página:110

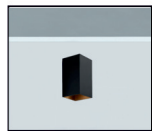

Box 90 Techo
Página:110



Cilim 120 Luz D/I
Página:109



Cilim 120 Luz Directa
Página:109

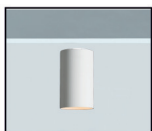

Cilim 120 Techo
Página:109



Cover 120
Página:101



Cover 90
Página:102



Cilim 85 Luz D/I
Página:111



Cilim 85 Luz Directa
Página:111

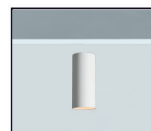

Cilim 85 Techo
Página:111



Sumer 38
Página:117

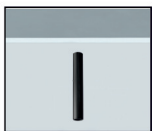

Sumer 50
Página:117



Dinwall
Página:113

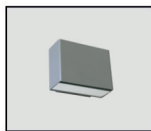

Seo Luz D/I
Página:115

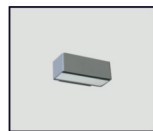

Seo Luz Directa
Página:115

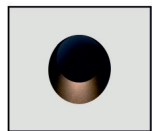

Eclipse
Página:112

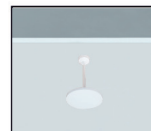

Domme 170
Página:114



MiniSpot Vitrina
Página:118

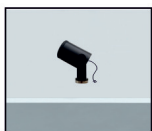

MiniSpot-25 base
Página:119



MiniSpot-35 base
Página:119



Stabilo Round
Página:120



Stabilo Square
Página:121

OUTDOOR LUMINARIES



Iris
Página:122

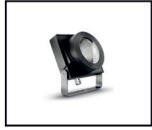

Iris
Página:122



Say
Página:123



MiniSpot 25 Suelo
Página:124



MiniSpot 25 Suelo
Página:125



MiniSpot 35 Suelo
Página:126



MiniSpot 35 Suelo
Página:127



Winter
Página:128

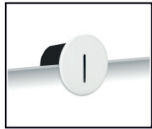

Free V1
Página:129

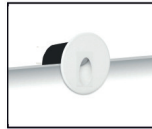

Free V2
Página:129



Line Light
Página:130

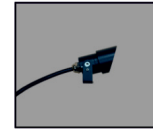

Smart Led
Página:131

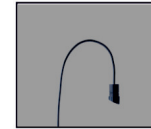

Flexus
Página:132

LED STRIP AND PROFILE



Led Strip
Página:134



Perfil Superficie
Página:135

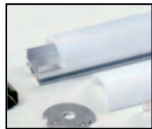

Perfil Superficie
Página:135

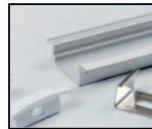

Perfil Empotrado
Página:135



Perfil Esquinero
Página:135



Drivers
Páginas:136

TRACKS



Trifasicos
Página:138

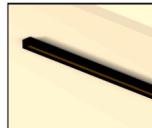

Carril 48V Superficie
Página:140



Carril 48v Empotrado
Página:141

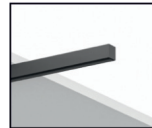

Carril 24V Superficie
Página:142

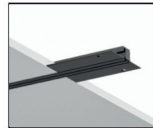

Carril 24V Empotrado
Página:143

RECESSED SYSTEMS

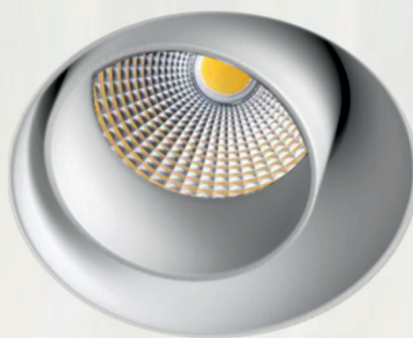

RECESSED SYSTEMS

LUZ&COLOR 2000

CROM TRIMLESS

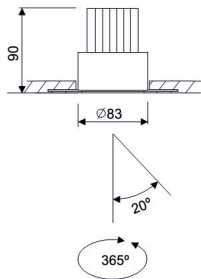
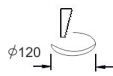
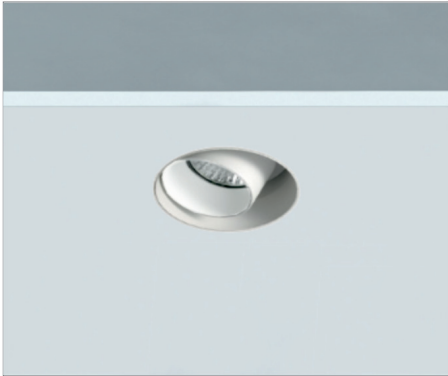

CÓDIGO

W Lumen K CRI

LC-11130-DE-0-27	8	926	2700	95
LC-11131-DE-0-30	8	976	3000	95



SISTEMAS DE REGULACIÓN:

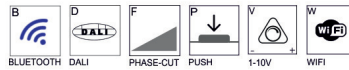

ACCESORIOS:

REF. AC-xxx :
DIFUSOR HIELO

REF. AC-520 :
ÓPTICA 15°

REF. AC-521 :
ÓPTICA 30°

REF. AC-522 :
ÓPTICA 50°

CROM TRIMLESS MR16

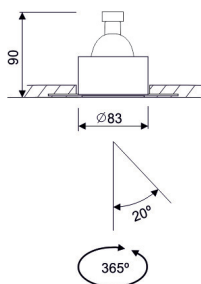
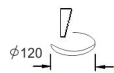
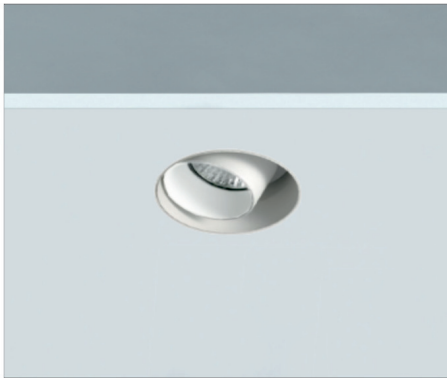

CÓDIGO

W Lumen K CRI

LC-11132-DE-0-00	"Según Lámpara MR16"			
------------------	----------------------	--	--	--

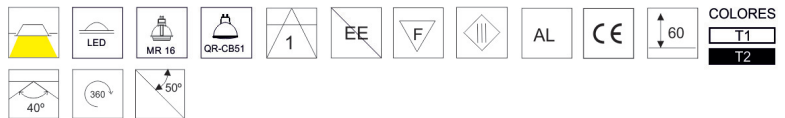

RECESSED SYSTEMS

LUZ&COLOR 2000

BK ROUND TRIMLESS

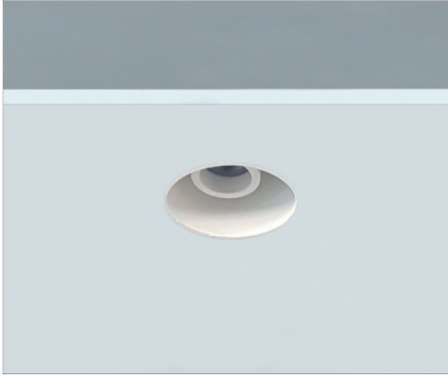

CÓDIGO

W

Lumen

K

CRI

LC-11190-DE-0-27

8

926

2700

95

LC-11190-DE-0-30

8

976

3000

95



SISTEMAS DE REGULACIÓN:

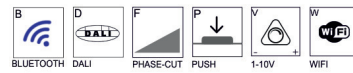

ACCESORIOS:



REF. AC-525 :
ÓPTICA 15°



REF. AC-526 :
ÓPTICA 30°



REF. AC-527 :
ÓPTICA 60°

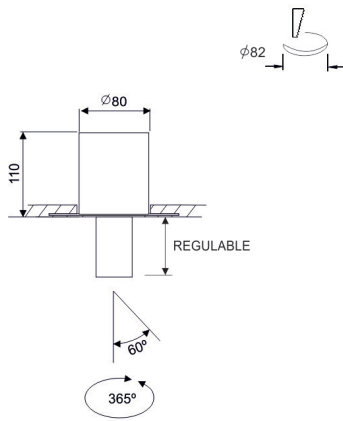

CUSTOMMADE



RECESSED SYSTEMS

LUZ&COLOR 2000

BK SQUARE TRIMLESS

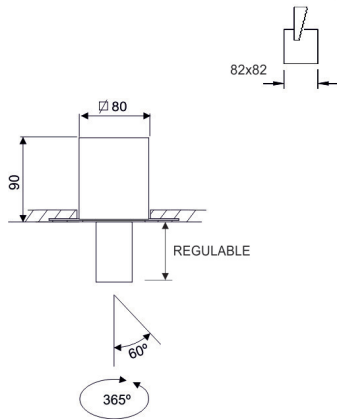

CÓDIGO

LC-11195-DE-0-27
LC-11195-DE-0-30

W Lumen K CRI

8 926 2700 95
8 976 3000 95



SISTEMAS DE REGULACIÓN:

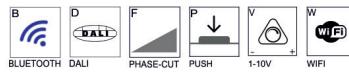

ACCESORIOS:



BK SQUARE DOBLE TRIMLESS

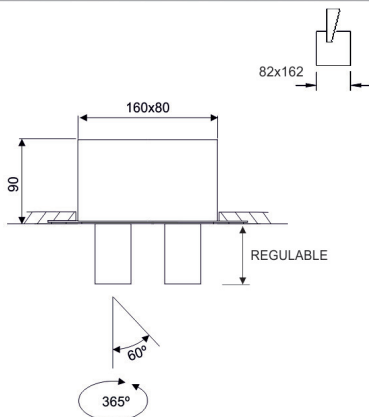

CÓDIGO

LC-11196-DE-0-27
LC-11196-DE-0-30

W Lumen K CRI

2x8 2x926 2700 95
2x8 2x976 3000 95



SISTEMAS DE REGULACIÓN:

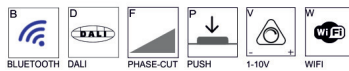

ACCESORIOS:



RECESSED SYSTEMS

LUZ&COLOR 2000

ADA 1

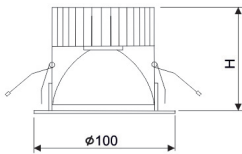
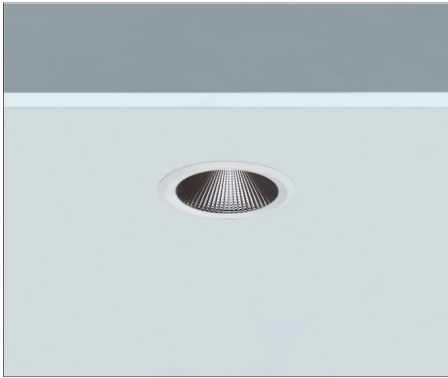

CÓDIGO	W	Lumen	K	CRI	H(mm)
--------	---	-------	---	-----	-------

LC-10500-DE-0-30	12	1800	3000	>90	95
LC-10500-DE-0-40	12	1900	4000	>90	95
LC-10501-DE-0-30	17	2600	3000	>90	115
LC-10501-DE-0-40	17	2700	4000	>90	115
LC-10502-DE-0-30	24	3197	3000	>90	125
LC-10502-DE-0-40	24	3331	4000	>90	125

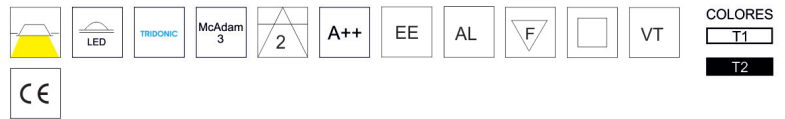

SISTEMAS DE REGULACIÓN:

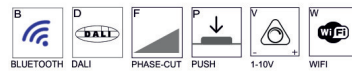

ACCESORIOS:

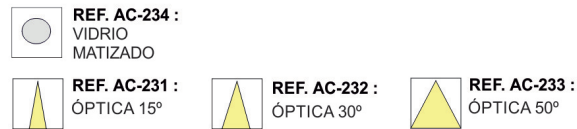

ADA 2

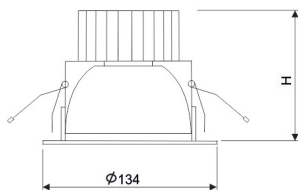
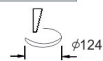
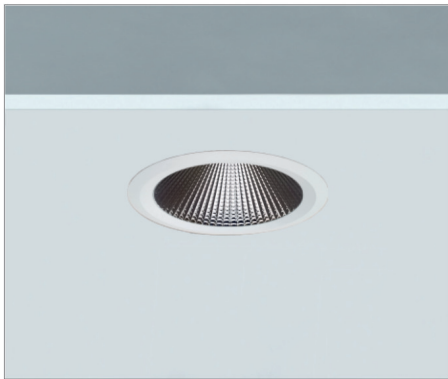

CÓDIGO	W	Lumen	K	CRI	H(mm)
--------	---	-------	---	-----	-------

LC-10510-DE-0-30	12	1800	3000	>90	100
LC-10510-DE-0-40	12	1900	4000	>90	100
LC-10511-DE-0-30	17	2600	3000	>90	120
LC-10511-DE-0-40	17	2700	4000	>90	120
LC-10512-DE-0-30	24	3197	3000	>90	130
LC-10512-DE-0-40	24	3331	4000	>90	130

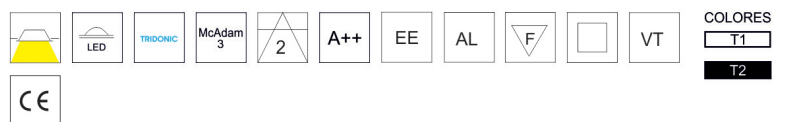

SISTEMAS DE REGULACIÓN:

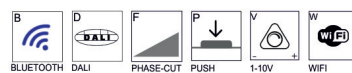

ACCESORIOS:



CUSTOMMADE



RECESSED SYSTEMS

LUZ&COLOR 2000

ADA 3

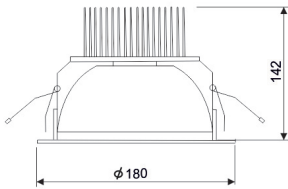

CÓDIGO **W** **Lumen** **K** **CRI** **Ángulo**

LC-10520-DE-0-30	17	2600	3000	>90	60°
LC-10520-DE-0-40	17	2700	4000	>90	60°
LC-10521-DE-0-30	24	3197	3000	>90	60°
LC-10521-DE-0-40	24	3331	4000	>90	60°
LC-10522-DE-0-30	37	4807	3000	>90	60°
LC-10522-DE-0-40	37	5018	4000	>90	60°



COLORES

T1

T2



SISTEMAS DE REGULACIÓN



BLUETOOTH

DALI

PHASE-CUT

PUSH

1-10V

WIFI

ACCESORIOS:



REF. AC-532 :
VIDRIO
MICROPRISMATICO



RECESSED SYSTEMS

LUZ&COLOR 2000

ROAD

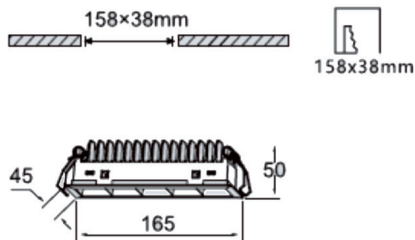

CÓDIGO

W Lumen K CRI

AZ-120543-DE-0-27	15	1200	2700	>90
AZ-120543-DE-0-30	15	1300	3000	>90

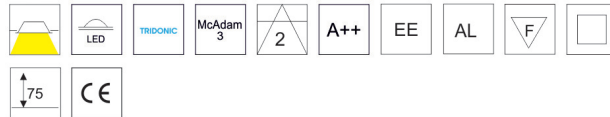

COLORES



SISTEMAS DE REGULACIÓN:

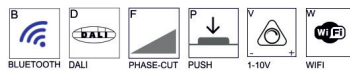

ACCESORIOS:

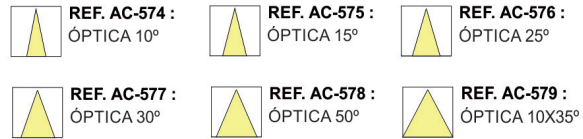

ROAD TRIMLESS

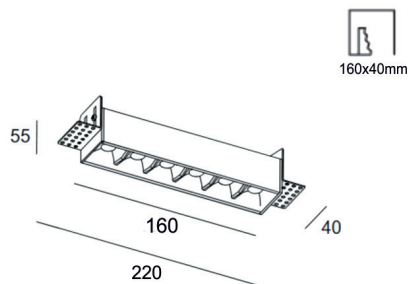

CÓDIGO

W Lumen K CRI

AZ-120544-DE-0-27	15	1200	2700	>90
AZ-120544-DE-0-30	15	1300	3000	>90

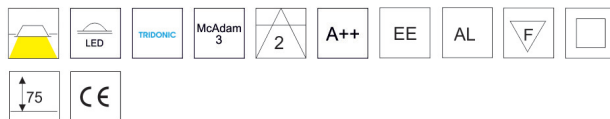

COLORES



SISTEMAS DE REGULACIÓN:

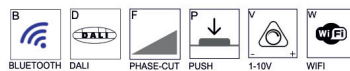

ACCESORIOS:

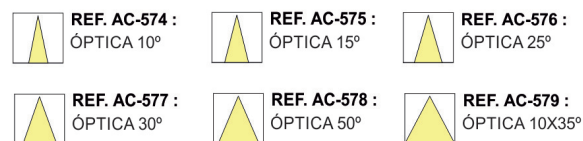

CUSTOMMADE



RECESSED SYSTEMS

LUZ&COLOR 2000

VEGA 85 SQUARE



75x75

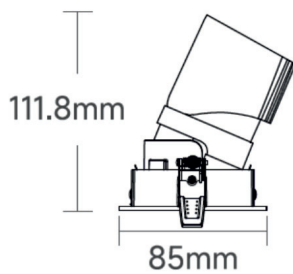

VEGA 85 ROUND



Ø85

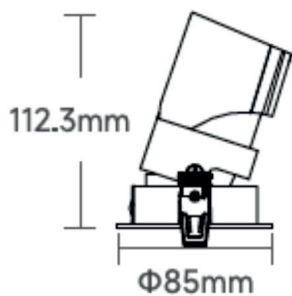

CÓDIGO

CÓDIGO	W	Lumen	K	CRI	H(mm)
AZ-120566-DE-0-27	10	800	2700	>90	112
AZ-120566-DE-0-30	10	900	3000	>90	112

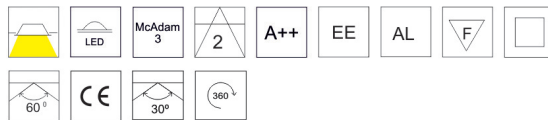

COLORES
T1
T2

SISTEMAS DE REGULACIÓN

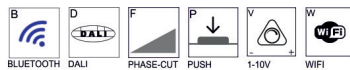

ACCESORIOS:



REF. AC-543 : ARO TRIMLESS

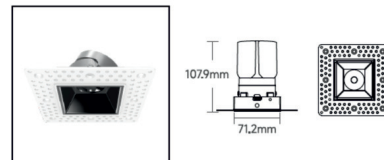

CÓDIGO

CÓDIGO	W	Lumen	K	CRI	H(mm)
AZ-120567-DE-0-27	10	800	2700	>90	113
AZ-120567-DE-0-30	10	900	3000	>90	113

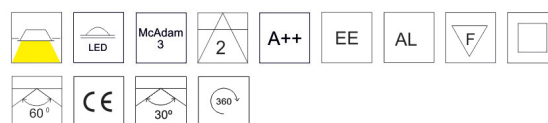

COLORES
T1
T2

SISTEMAS DE REGULACIÓN

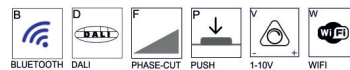

ACCESORIOS:



REF. AC-544 : ARO TRIMLESS



RECESSED SYSTEMS

LUZ&COLOR 2000

C1 BASCULANTE

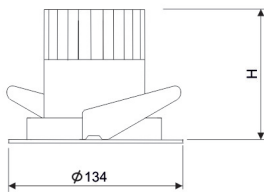

CÓDIGO	W	Lumen	K	CRI	H(mm)
--------	---	-------	---	-----	-------

LC-10540-DE-0-30	12	1800	3000	>90	95
LC-10540-DE-0-40	12	1900	4000	>90	95
LC-10541-DE-0-30	17	2600	3000	>90	115
LC-10541-DE-0-40	17	2700	4000	>90	115
LC-10542-DE-0-30	24	3200	3000	>90	125
LC-10542-DE-0-40	24	3300	4000	>90	125

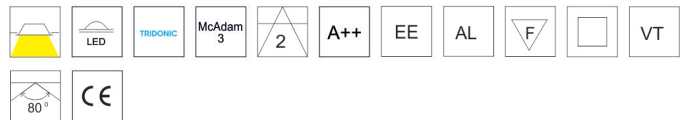

COLORES



SISTEMAS DE REGULACIÓN:

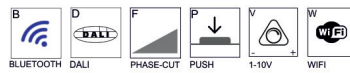

ACCESORIOS:

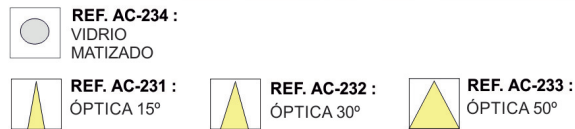

C2 BASCULANTE

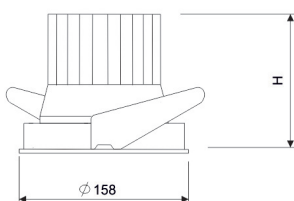
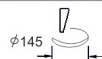

CÓDIGO	W	Lumen	K	CRI	H(mm)
--------	---	-------	---	-----	-------

LC-10550-DE-0-30	12	1800	3000	>90	95
LC-10550-DE-0-40	12	1900	4000	>90	95
LC-10551-DE-0-30	17	2600	3000	>90	115
LC-10551-DE-0-40	17	2700	4000	>90	115
LC-10552-DE-0-30	24	3200	3000	>90	125
LC-10552-DE-0-40	24	3300	4000	>90	125

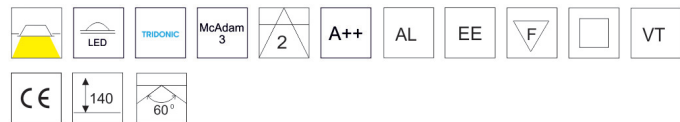

COLORES



SISTEMAS DE REGULACIÓN:

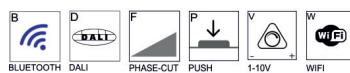

ACCESORIOS:



RECESSED SYSTEMS

LUZ&COLOR 2000

LOTSE

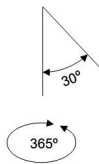
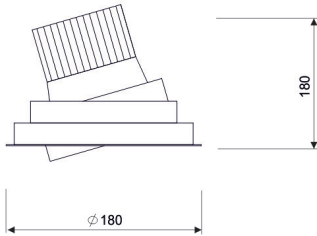
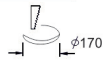

CÓDIGO

W

Lumen

K

CRI

LC-11220-DE-0-30	17	2600	3000	>90
LC-11220-DE-0-40	17	2700	4000	>90
LC-11221-DE-0-30	24	3197	3000	>90
LC-11221-DE-0-40	24	3331	4000	>90

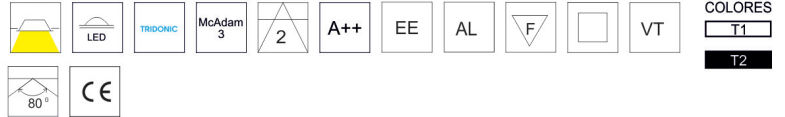

SISTEMAS DE REGULACIÓN:

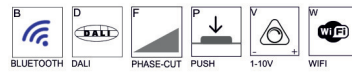

ACCESORIOS:





RECESSED SYSTEMS

LUZ&COLOR 2000

BLOCK 128 Trimless

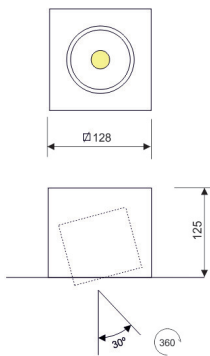
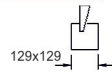
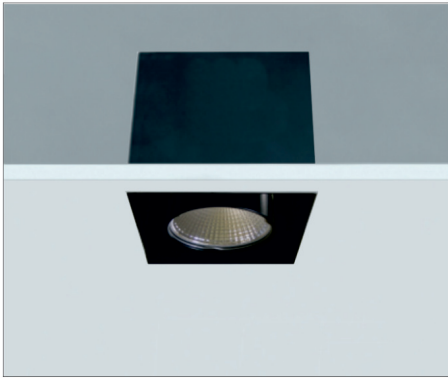

CÓDIGO

W Lumen K CRI

LC-11030-DE-0-27	12	1700	2700	>90
LC-11030-DE-0-30	12	1800	3000	>90
LC-11030-DE-0-40	12	1900	4000	>90



SISTEMAS DE REGULACIÓN

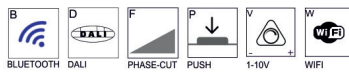

ACCESORIOS:



BLOCK 128 con marco

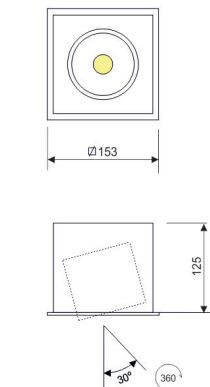
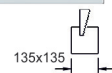

CÓDIGO

AC-420 "Marco Simple Block 128"

COLORES



RECESSED SYSTEMS

LUZ&COLOR 2000

BLOCK 128 Trimless

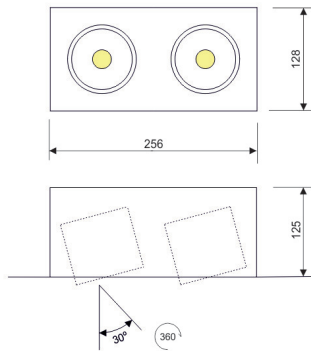
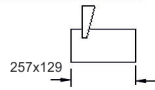
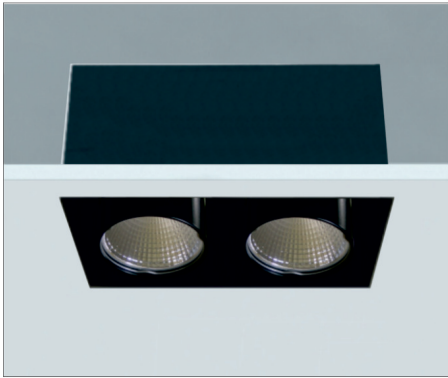

CÓDIGO

W Lumen K CRI

LC-11031-DE-0-27	2x12	2x1700	2700	>90
LC-11031-DE-0-30	2x12	2x1800	3000	>90
LC-11031-DE-0-40	2x12	2x1900	4000	>90

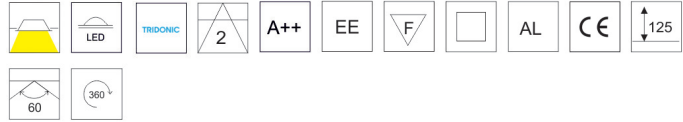

COLORES
T2

SISTEMAS DE REGULACIÓN

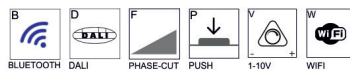

ACCESORIOS:



BLOCK 128 con marco

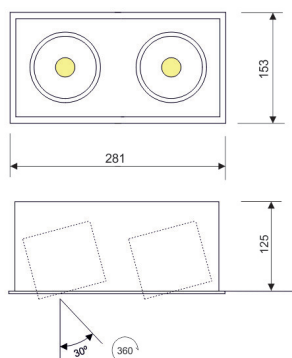
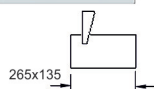

CÓDIGO

AC-421 "Marco Doble Block 128"

COLORES
T1
T2

CUSTOMMADE



RECESSED SYSTEMS

LUZ&COLOR 2000

MINI BLOCK Simple

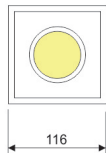
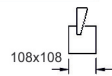

CÓDIGO

W Lumen K CRI

LC-11020-DE-0-27	8	926	2700	>90
LC-11020-DE-0-30	8	976	3000	>90



SISTEMAS DE REGULACIÓN:



ACCESORIOS:

REF. AC-523 :
DIFUSOR HIELO

REF. AC-520 :
ÓPTICA 15°

REF. AC-521 :
ÓPTICA 30°

REF. AC-522 :
ÓPTICA 50°

MINI BLOCK Doble

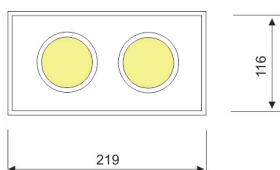
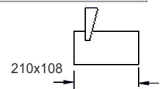

CÓDIGO

W Lumen K CRI

LC-11022-DE-0-27	2x8	2x926	2700	>90
LC-11022-DE-0-30	2x8	2x926	3000	>90



SISTEMAS DE REGULACIÓN:

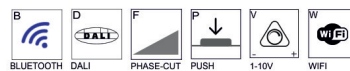

ACCESORIOS:

REF. AC-523 :
DIFUSOR HIELO

REF. AC-520 :
ÓPTICA 15°

REF. AC-521 :
ÓPTICA 30°

REF. AC-522 :
ÓPTICA 50°

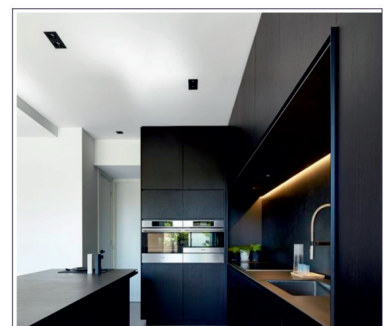

RECESSED SYSTEMS

LUZ&COLOR 2000

LINE BLOCK Trimless

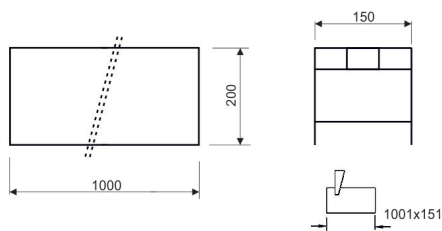

CÓDIGO

LC-11160-DE-0-00 CARCASA EMPOTRADA 1ml
+ CARRIL ELECTRIFICADO 1ml



CÓDIGO

CÓDIGO	W	Lumen	K	CRI
LC-11165-PC-0-30	12	1800	3000	>90
LC-11165-PC-0-40	12	1900	4000	>90

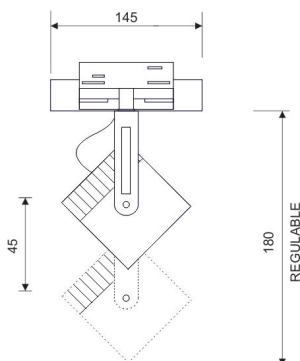

SISTEMAS DE REGULACIÓN

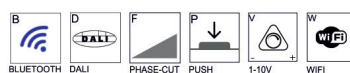

ACCESORIOS:

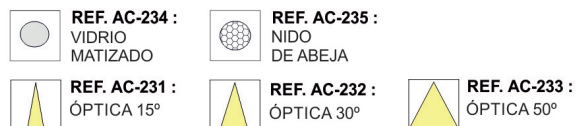

CUSTOMMADE





GAUSS LED



RECESSED SYSTEMS

LUZ&COLOR 2000

GAUSS SIMPLE

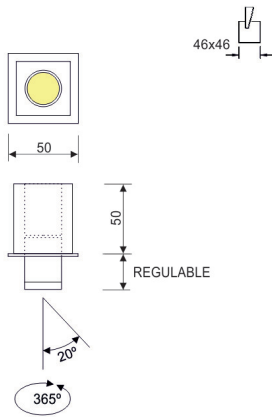

CÓDIGO

LC-11120-DE-0-27
LC-11120-DE-0-30

W Lumen K CRI

3 320 2700 95
3 350 3000 95



SISTEMAS DE REGULACIÓN

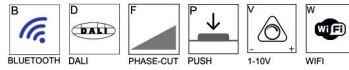

ACCESORIOS:

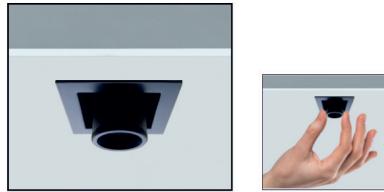

GAUSS DOBLE

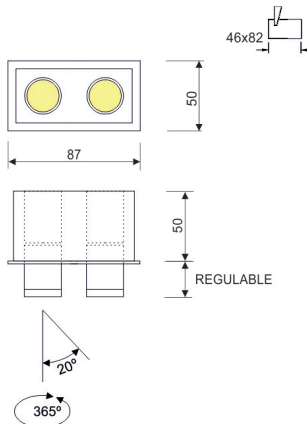

CÓDIGO

LC-11121-DE-0-27
LC-11121-DE-0-30

W Lumen K CRI

2x3 2x320 2700 95
2x3 2x350 3000 95



SISTEMAS DE REGULACIÓN

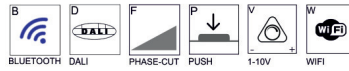

ACCESORIOS:



CUSTOMMADE



RECESSED SYSTEMS

LUZ&COLOR 2000

GAUSS Trimless SIMPLE

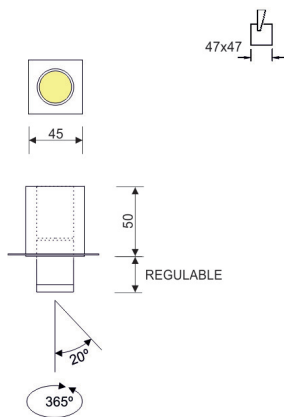

CÓDIGO

LC-11170-DE-0-27
LC-11170-DE-0-30

W Lumen K CRI

3 320 2700 95
3 350 3000 95



COLORES
01
02

SISTEMAS DE REGULACIÓN

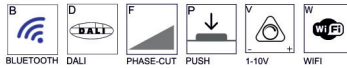

ACCESORIOS:

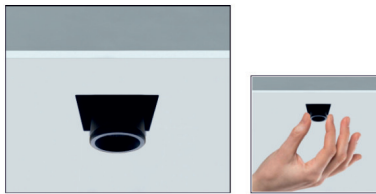

GAUSS Trimless DOBLE

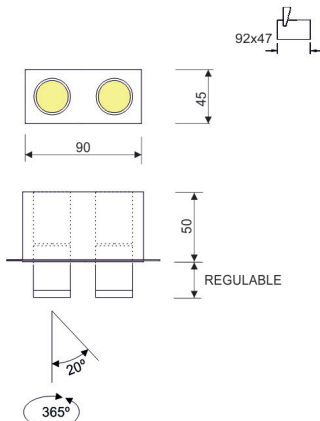
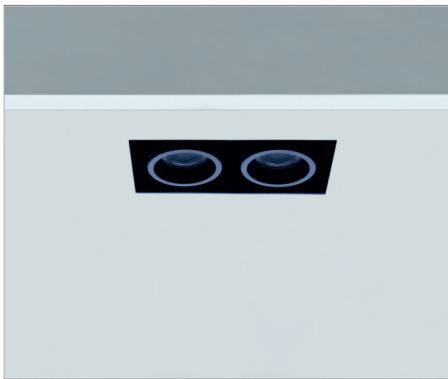

CÓDIGO

LC-11171-DE-0-27
LC-11171-DE-0-30

W Lumen K CRI

2x3 2x320 2700 95
2x3 2x350 3000 95



COLORES
01
02

SISTEMAS DE REGULACIÓN

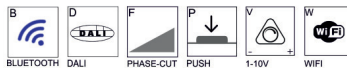

ACCESORIOS:



RECESSED SYSTEMS

LUZ&COLOR 2000

FLY-C 220

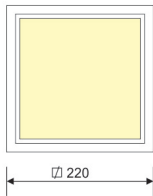
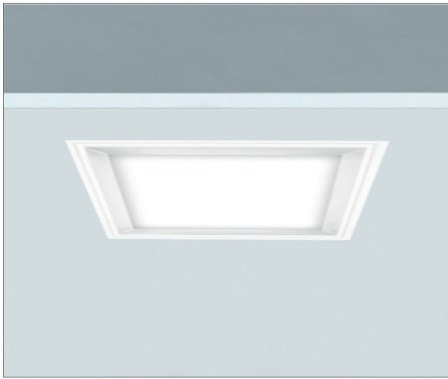

CÓDIGO	W	Lumen	K	CRI	Ángulo
--------	---	-------	---	-----	--------

LC-11000-DE-0-30	25	2050	3000	>80	95°
LC-11000-DE-0-40	25	2150	4000	>80	95°



SISTEMAS DE REGULACIÓN

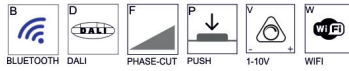

FLY-C 140

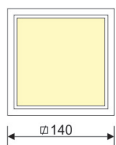

CÓDIGO	W	Lumen	K	CRI	Ángulo
--------	---	-------	---	-----	--------

LC-11001-DE-0-30	12	990	3000	>80	95°
LC-11001-DE-0-40	12	1060	4000	>80	95°

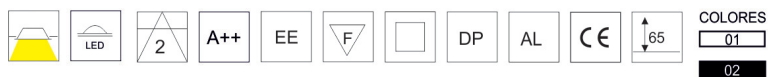

SISTEMAS DE REGULACIÓN

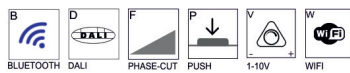

CUSTOMMADE



RECESSED SYSTEMS

LUZ&COLOR 2000

FLY 230

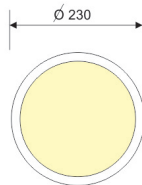

CÓDIGO	W	Lumen	K	CRI	Ángulo
--------	---	-------	---	-----	--------

LC-11010-DE-0-30	25	2050	3000	>80	95°
------------------	----	------	------	-----	-----

LC-11010-DE-0-40	25	2150	4000	>80	95°
------------------	----	------	------	-----	-----



COLORES

01

07

02

FLY 140

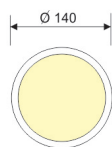
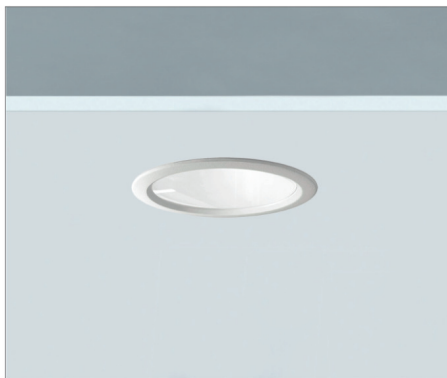

CÓDIGO	W	Lumen	K	CRI	Ángulo
--------	---	-------	---	-----	--------

LC-11011-DE-0-30	12	990	3000	>80	95°
------------------	----	-----	------	-----	-----

LC-11011-DE-0-40	12	1060	4000	>80	95°
------------------	----	------	------	-----	-----



COLORES

01

07

02



CUSTOMMADE



RECESSED SYSTEMS

LUZ&COLOR 2000

FORD 134

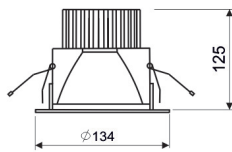

CÓDIGO

CÓDIGO	W	Lumen	K	CRI	Ángulo
LC-11050-DE-0-30	8	1300	3000	>80	60°
LC-11050-DE-0-40	8	1400	4000	>80	60°
LC-11051-DE-0-30	17	2440	3000	>80	60°
LC-11051-DE-0-40	17	2540	4000	>80	60°



SISTEMAS DE REGULACIÓN

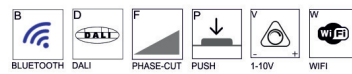

FORD 180

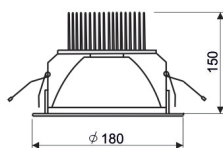

CÓDIGO

CÓDIGO	W	Lumen	K	CRI	Ángulo
LC-11052-DE-0-30	15	2440	3000	>80	60°
LC-11052-DE-0-40	15	2540	4000	>80	60°
LC-11053-DE-0-30	24	3600	3000	>80	60°
LC-11053-DE-0-40	24	3700	4000	>80	60°



SISTEMAS DE REGULACIÓN

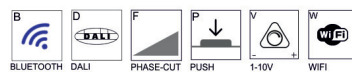

CUSTOMMADE



RECESSED SYSTEMS

LUZ&COLOR 2000

LESOR 30

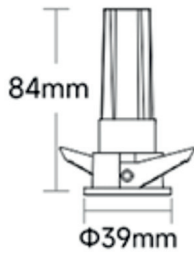

CÓDIGO

LC-11735-DE-0-27
LC-11735-DE-0-30

W Lumen K CRI

5 380 2700 95
5 430 3000 95



SISTEMAS DE REGULACIÓN:



ACCESORIOS:

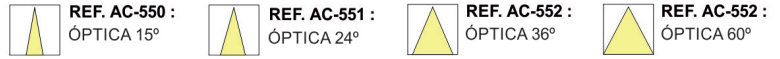

LESOR 30 TRIMLESS

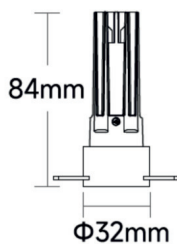

CÓDIGO

LC-11702-DE-0-27
LC-11702-DE-0-30

W Lumen K CRI

5 380 2700 95
5 430 3000 95



SISTEMAS DE REGULACIÓN:

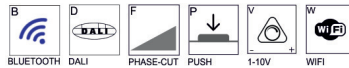

ACCESORIOS:



CUSTOMMADE



LESOR 60

CÓDIGO

W

Lumen

K

CRI

Firma electrónica

Buscar texto o herramientas



DM50

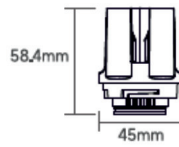

Trim For Hotel Series

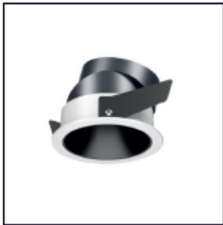

DM50-DF51RA01N

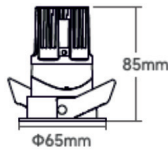

Round Adjustable



Round Adjustable Trimless

DM50-DF51RA01T

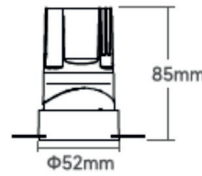

Trim For Commercial Series



DM50-DF53RA01N

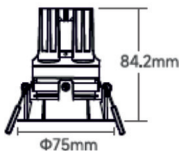

Round Adjustable



Square Adjustable

DM50-DF53SA01N

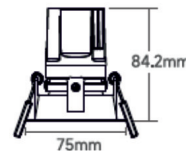

DM50-DF53SA02N



DM50-DF53SA03N



216 x 303 mm

RECESSED SYSTEMS

LUZ&COLOR 2000

LESOR 80

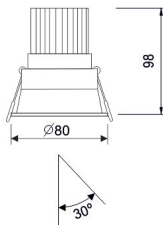

CÓDIGO

LC-11060-DE-0-27
LC-11060-DE-0-30

W

Lumen

K

CRI

8
8

926
976

2700
3000

95
95



SISTEMAS DE REGULACIÓN:

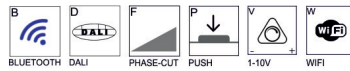

ACCESORIOS:



LESOR MR16/GU10

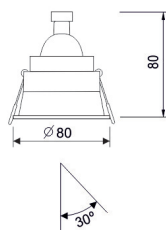

CÓDIGO

LC-11062-DE-0-00

W

Lumen

K

CRI

"Según Lámpara MR16"

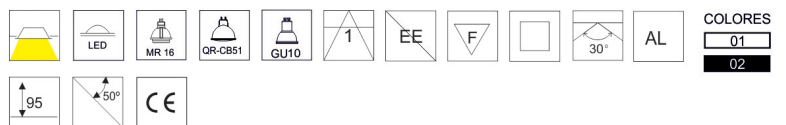

CUSTOMMADE



RECESSED SYSTEMS

LUZ&COLOR 2000

TAU-R (EQUIPO ELECTRÓNICO)

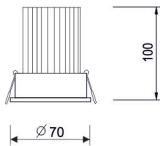
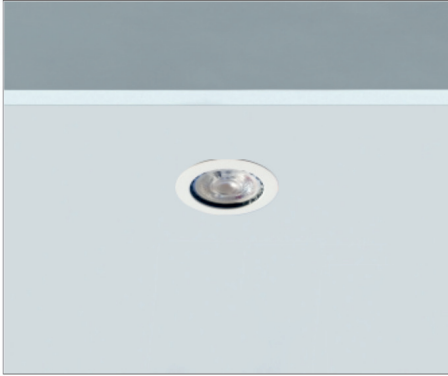

CÓDIGO

CÓDIGO	W	Lumen	K	CRI
LC-11105-DE-0-27	8	926	2700	95
LC-11105-DE-0-30	8	976	3000	95



COLORES
01
02

SISTEMAS DE REGULACIÓN:

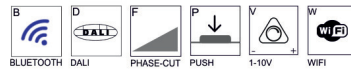

ACCESORIOS:

REF. AC-523 :
DIFUSOR HIELO

REF. AC-520 :
ÓPTICA 15°

REF. AC-521 :
ÓPTICA 30°

REF. AC-522 :
ÓPTICA 50°

TAU-R (DIRECTO A RED)

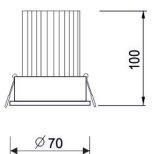
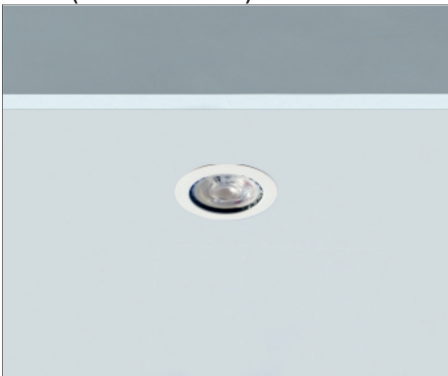

CÓDIGO

CÓDIGO	W	Lumen	K	CRI	
LC-11107-DE-0-27	9	770	2700	>90	36°
LC-11108-DE-0-27	9	770	2700	>90	24°
LC-11107-DE-0-30	9	840	3000	>90	36°
LC-11108-DE-0-30	9	840	3000	>90	24°

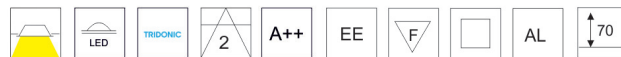

COLORES
01
02

SISTEMAS DE REGULACIÓN:

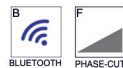

RECESSED SYSTEMS

LUZ&COLOR 2000

LAMBER 280 WALLWASHER TRIMLESS

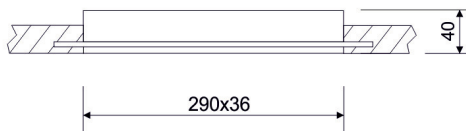
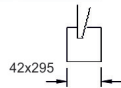
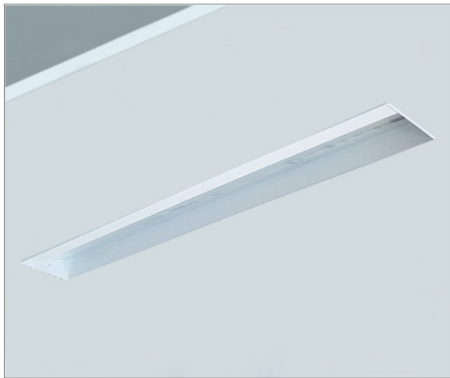

CÓDIGO

CÓDIGO	W	Lumen	K	CRI
LC-11200-DE-0-27	15	1800	2700	>90
LC-11200-DE-0-30	15	1900	3000	>90



COLORES



-Se monta con difusor opal

SISTEMAS DE REGULACIÓN:

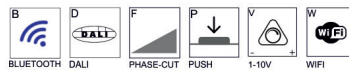

ACCESORIOS:

REF. AC-560 :
LENTE WALLWASHER 280

LAMBER 140 WALLWASHER TRIMLESS

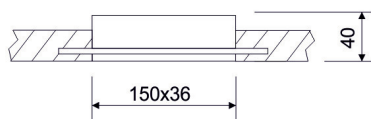
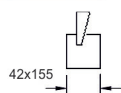

CÓDIGO

CÓDIGO	W	Lumen	K	CRI
LC-11205-DE-0-27	9	800	2700	>90
LC-11205-DE-0-30	9	900	3000	>90



COLORES



-Se monta con difusor opal

SISTEMAS DE REGULACIÓN:

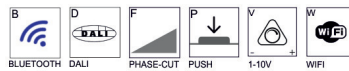

ACCESORIOS:

REF. AC-560 :
LENTE WALLWASHER 280

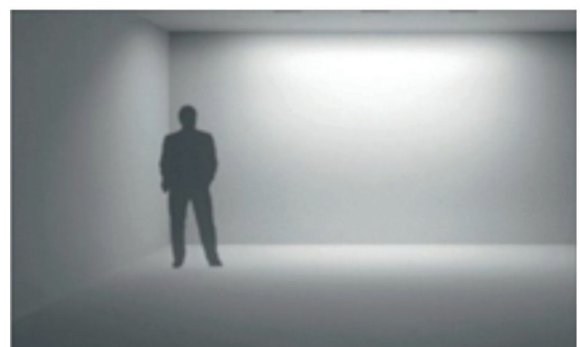

CUSTOMMADE



RECESSED SYSTEMS

LUZ&COLOR 2000

PANTALLA POLIVALENTE 37W

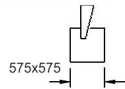
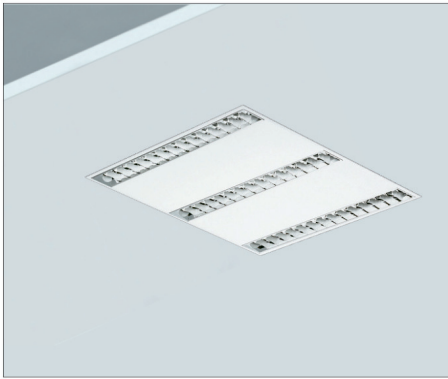

CÓDIGO

W Lumen K CRI

LC-11140-DE-0-30	37	4900	3000	>80
LC-11140-DE-0-40	37	5090	4000	>80



SISTEMAS DE REGULACIÓN:

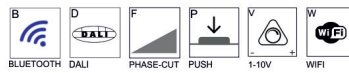

PANTALLA POLIVALENTE 25W

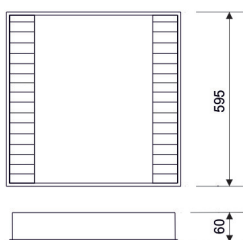
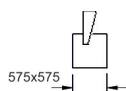
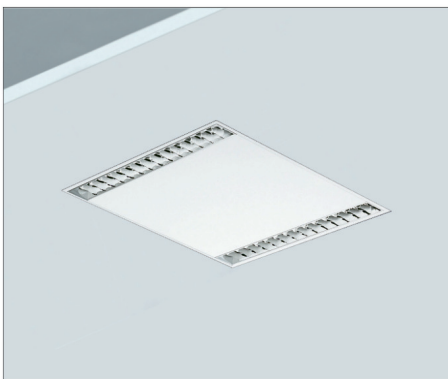

CÓDIGO

W Lumen K CRI

LC-11141-DE-0-30	25	3270	3000	>80
LC-11141-DE-0-40	25	3370	4000	>80



SISTEMAS DE REGULACIÓN:



RECESSED SYSTEMS

LUZ&COLOR 2000

PANEL LED

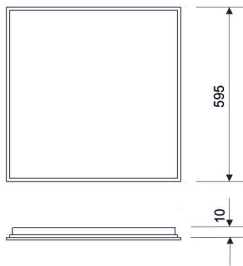
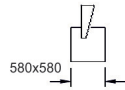
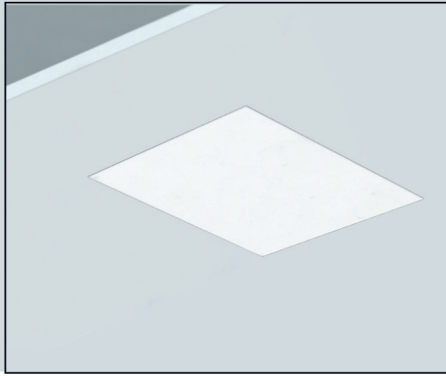

CÓDIGO

W

Lumen

K

CRI

LC-11142-DE-0-30

32

3600

3000

>80

LC-11142-DE-0-40

32

3800

4000

>80



UGR<19

SISTEMAS DE REGULACIÓN:

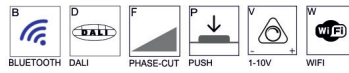

CUSTOMMADE



RECESSED SYSTEMS

LUZ&COLOR 2000

RUS APANTALLADA

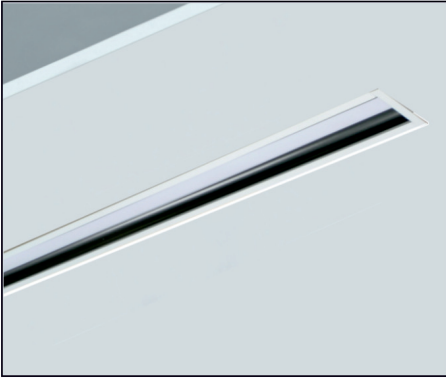

CÓDIGO	W	Lumen	K	CRI	LONGITUD(mm)
--------	---	-------	---	-----	--------------

LC-11150-DE-0-30	48	6940	3000	>90	1150
LC-11150-DE-0-40	48	7240	4000	>90	1150
LC-11151-DE-0-30	24	4080	3000	>90	1150
LC-11151-DE-0-40	24	4260	4000	>90	1150
LC-11152-DE-0-30	24	3470	3000	>90	590
LC-11152-DE-0-40	24	3620	4000	>90	590
LC-11153-DE-0-30	12	2040	3000	>90	590
LC-11153-DE-0-40	12	2130	4000	>90	590

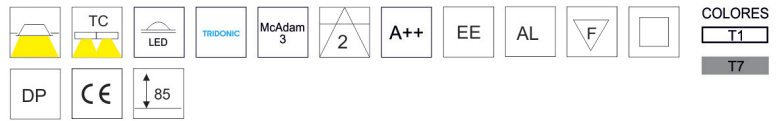
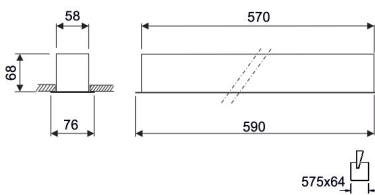
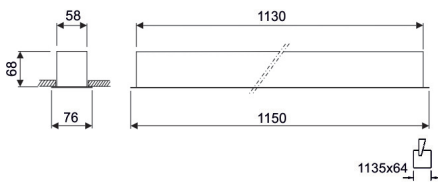

SISTEMAS DE REGULACIÓN:

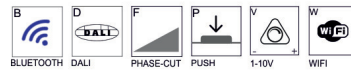

NOTA: APANTALLADO EN COLOR NEGRO TEXTURADO

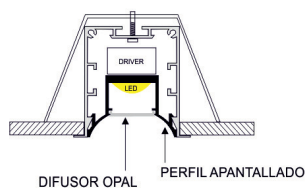

CUSTOMMADE





SERIE RUS LED EMPOTRADA - TIRA CONTINUA

RECESSED SYSTEMS

LUZ&COLOR 2000

RUS HIGH CONTRAST

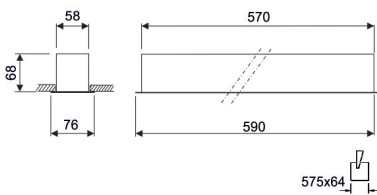
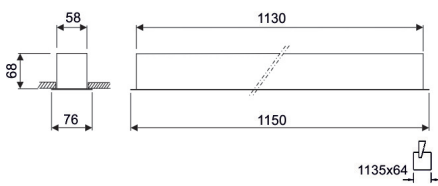
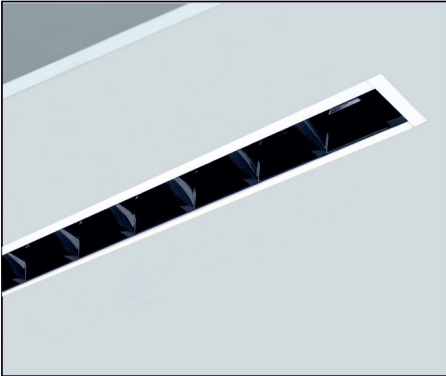

CÓDIGO	W	Lumen	K	CRI	LONGITUD(mm)
LC-11703-DE-0-30	48	6940	3000	>90	1150
LC-11703-DE-0-40	48	7240	4000	>90	1150
LC-11704-DE-0-30	24	4080	3000	>90	1150
LC-11704-DE-0-40	24	4260	4000	>90	1150
LC-11705-DE-0-30	24	3470	3000	>90	590
LC-11705-DE-0-40	24	3620	4000	>90	590
LC-11706-DE-0-30	12	2040	3000	>90	590
LC-11706-DE-0-40	12	2130	4000	>90	590

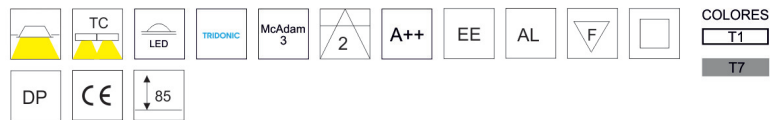

SISTEMAS DE REGULACIÓN:

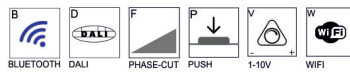

ACCESORIOS:

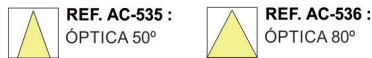

RECESSED SYSTEMS

LUZ&COLOR 2000

RUS OPAL

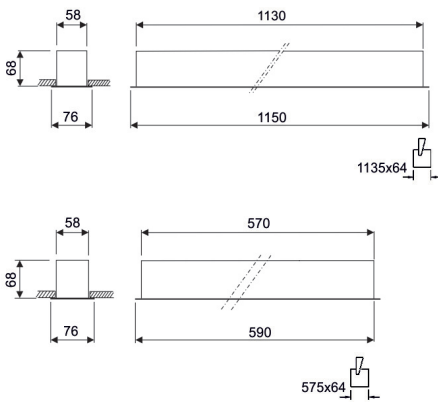
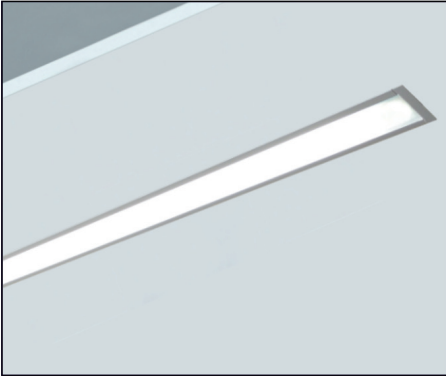

CÓDIGO	W	Lumen	K	CRI	LONGITUD(mm)
--------	---	-------	---	-----	--------------

LC-10580-DE-0-30	48	6940	3000	>90	1150
LC-10580-DE-0-40	48	7240	4000	>90	1150
LC-10581-DE-0-30	24	4080	3000	>90	1150
LC-10581-DE-0-40	24	4260	4000	>90	1150
LC-10582-DE-0-30	24	3470	3000	>90	590
LC-10582-DE-0-40	24	3620	4000	>90	590
LC-10583-DE-0-30	12	2040	3000	>90	590
LC-10583-DE-0-40	12	2130	4000	>90	590

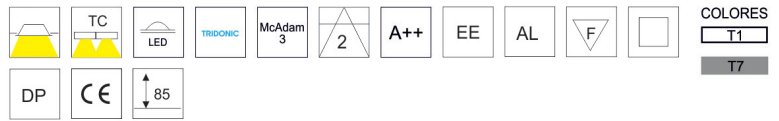

SISTEMAS DE REGULACIÓN:

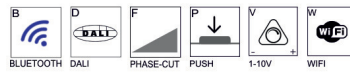

CUSTOMMADE



RECESSED SYSTEMS

LUZ&COLOR 2000

SLIM RUS OPAL

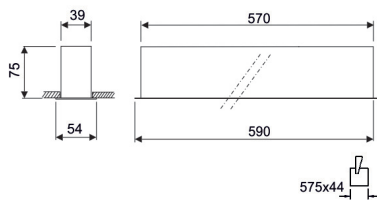
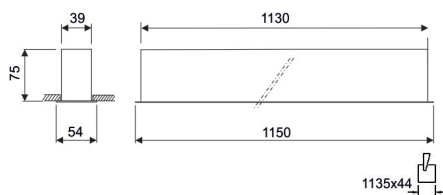
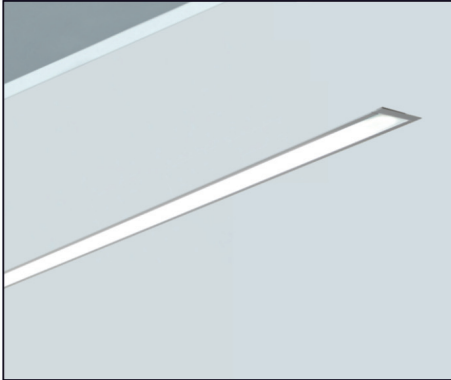

CÓDIGO	W	Lumen	K	CRI	LONGITUD(mm)
--------	---	-------	---	-----	--------------

LC-10590-DE-0-30	48	6940	3000	>90	1150
LC-10590-DE-0-40	48	7240	4000	>90	1150
LC-10591-DE-0-30	24	4080	3000	>90	1150
LC-10591-DE-0-40	24	4260	4000	>90	1150
LC-10592-DE-0-30	24	3470	3000	>90	590
LC-10592-DE-0-40	24	3620	4000	>90	590
LC-10593-DE-0-30	12	2040	3000	>90	590
LC-10593-DE-0-40	12	2130	4000	>90	590

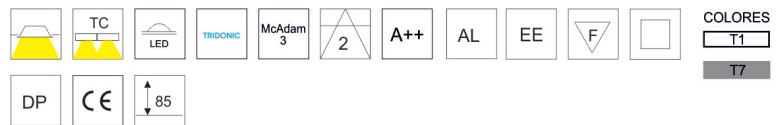

SISTEMAS DE REGULACIÓN:



MULTI-SYSTEM

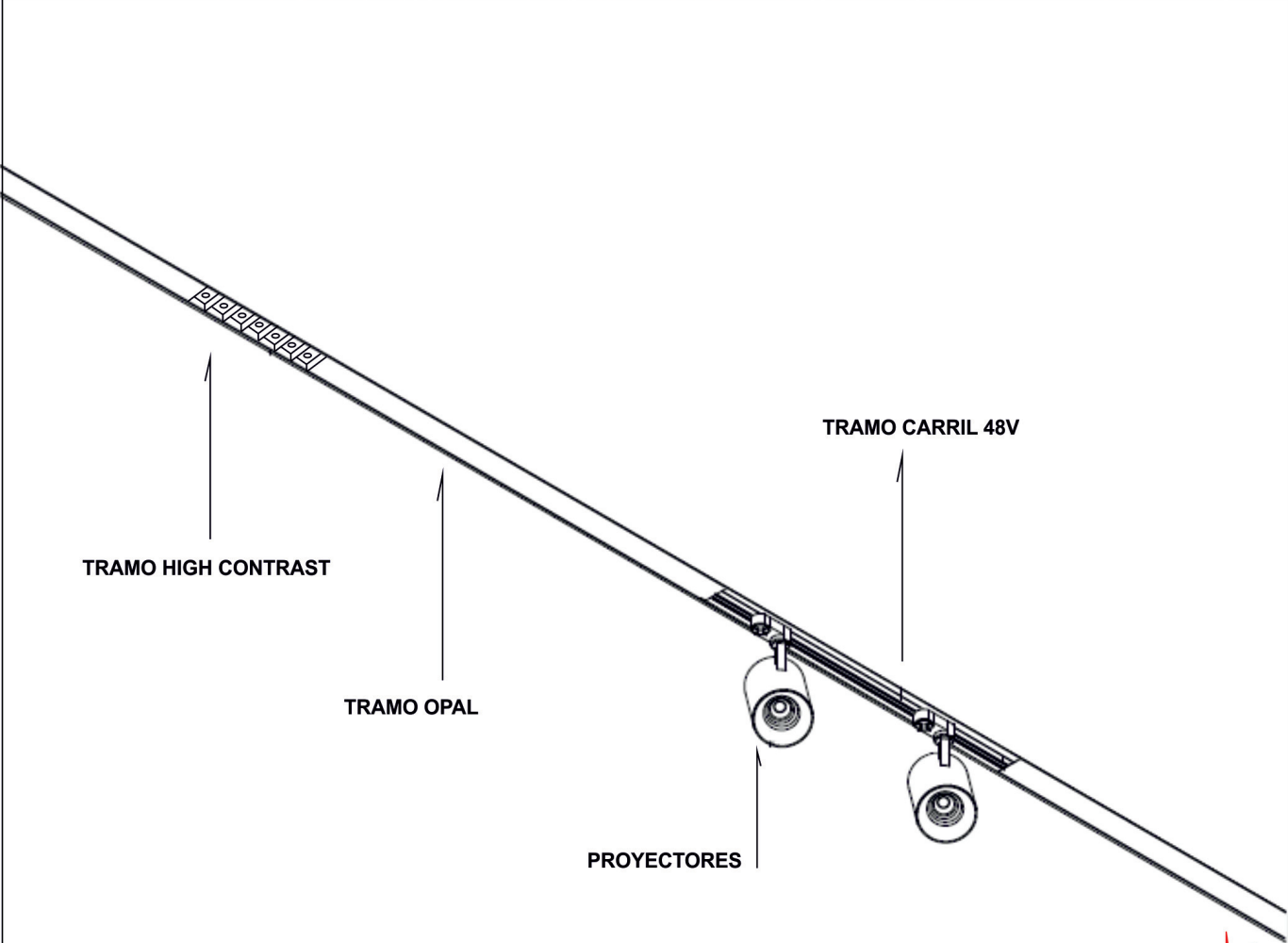
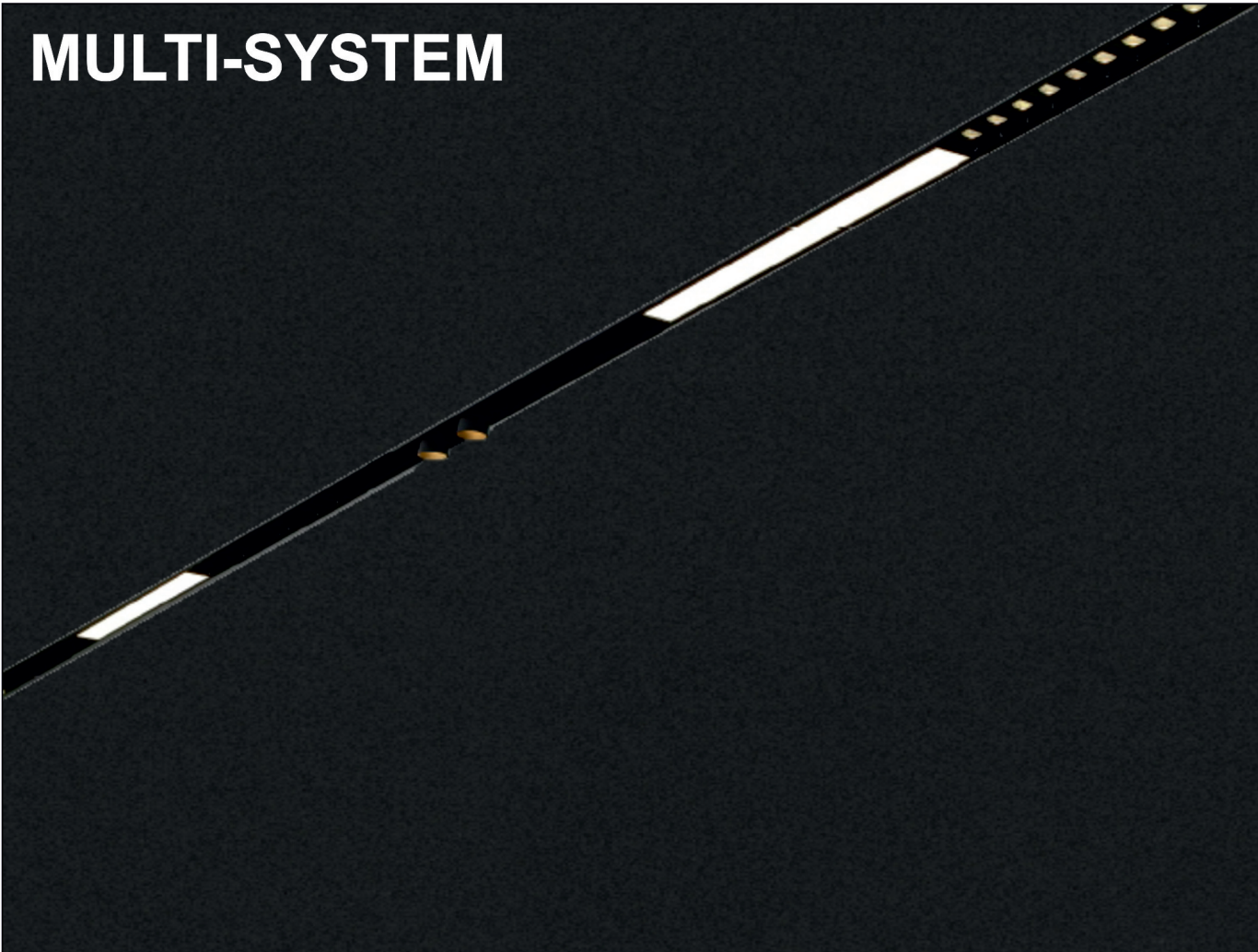

RECESSED SYSTEMS

LUZ&COLOR 2000

MULTI SYSTEM RUS

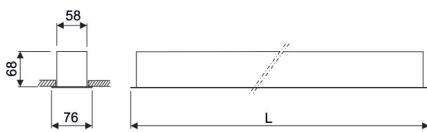

CÓDIGO

L(mm)

LC-11707-DE	PERFIL EMPOTRADO MULTI-SYSTEM	1000
LC-11708-DE	PERFIL EMPOTRADO MULTI-SYSTEM	2000
LC-11709-DE	PERFIL EMPOTRADO MULTI-SYSTEM	3000

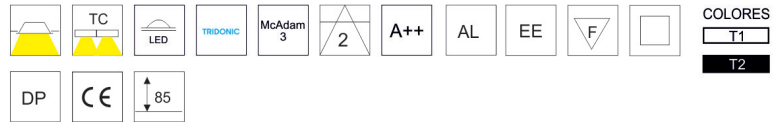

SISTEMAS DE REGULACIÓN:

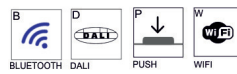

OPCIONES:

TRAMO OPAL

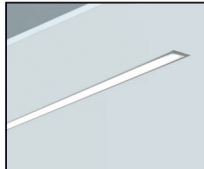

REF.	W	Lumen	K	CRI	L(mm)
LC-11710-00-0-27	12	1940	2700	>90	570
LC-11710-00-0-30	12	2040	3000	>90	570

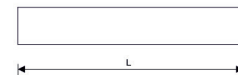

RM-2

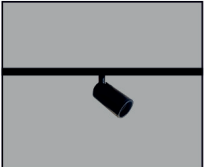

REF.	W	Lumen	K	CRI
LC-20487-PC-0-27	8	926	2700	95
LC-20487-PC-0-30	8	976	3000	95

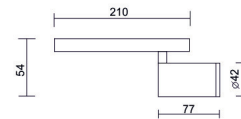

RM-3

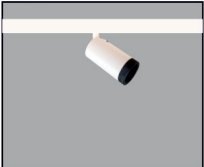

REF.	W	Lumen	K	CRI
LC-20488-PC-0-27	12	1100	2700	95
LC-20488-PC-0-30	12	1200	3000	95

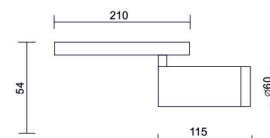

RECESSED SYSTEMS

LUZ&COLOR 2000

OPCIONES:

RIVER 90

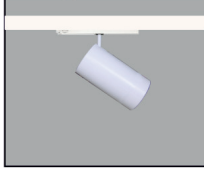

REF.	W	Lumen	K	CRI
LC-20466-PC-0-27	12	1700	2700	>90
LC-20466-PC-0-30	12	1800	3000	>90

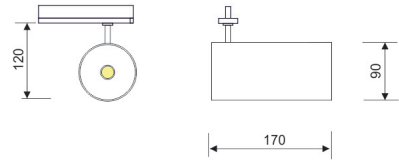

HIGH CONTRAST



REF.	W	Lumen	K	CRI	L(mm)
LC-11711-00-0-27	17	2500	2700	>90	280
LC-11711-00-0-30	17	2600	3000	>90	280

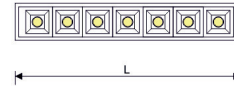

HIGH CONTRAST 48V



REF.	W	Lumen	K	CRI	L(mm)
LC-11712-00-0-27	4	500	2700	>90	140
LC-11712-00-0-30	4	600	3000	>90	140

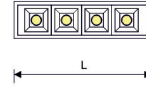

TAPA CIEGA



REF.	W	Lumen	K	CRI	L(mm)
AC-573					1000

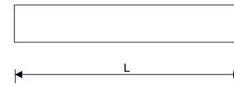

BALL 10



REF.	W	Lumen	K	CRI	L(mm)
AZ-120082-SD-0-27	3	320	2700	>90	280
AZ-120082-SD-0-30	3	350	3000	>90	280

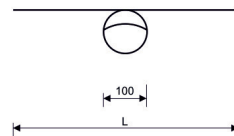

COVER 90 SUSPENDIDO

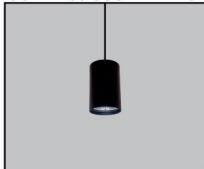

REF.	W	Lumen	K	CRI	L(mm)
LC-51140-SD-0-27	12	1700	2700	>90	280
LC-51140-SD-0-30	12	1800	3000	>90	280

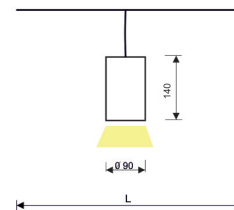

CARRILES: PÁGINAS 130-131

CUSTOMMADE

