



SURFACE LUMINARIES

SURFACE LUMINARIES

LUZ&COLOR 2000

SCALA

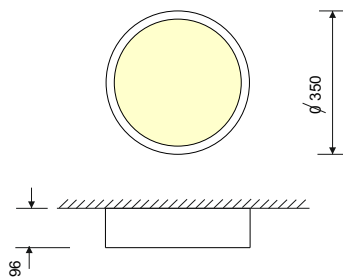
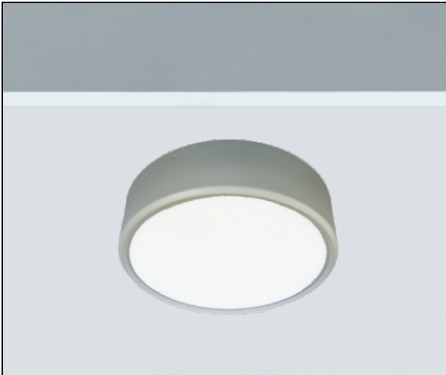

CÓDIGO

CÓDIGO	W	Lumen	K	CRI
LC-51000-SD-0-30	18	2600	3000	>80
LC-51000-SD-0-40	18	2840	4000	>80
LC-51005-SD-0-30	30	3750	3000	>80
LC-51005-SD-0-40	30	4090	4000	>80

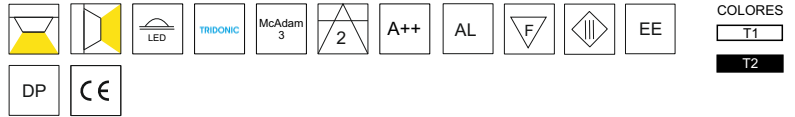

SISTEMAS DE REGULACIÓN:

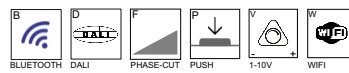

ROUND

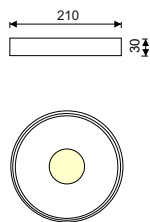

CÓDIGO

CÓDIGO	W	Lumen	K	CRI	°
LC-51080-SD-0-30	18	1800	3000	>80	110



SISTEMAS DE REGULACIÓN:

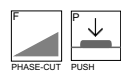

SURFACE LUMINARIES

LUZ&COLOR 2000

COVER 120

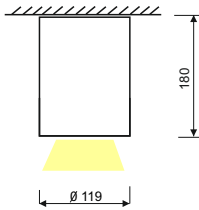

CÓDIGO

CÓDIGO	W	Lumen	K	CRI
LC-51105-SD-0-27	12	1700	2700	>90
LC-51105-SD-0-30	12	1800	3000	>90
LC-51105-SD-0-40	12	1900	4000	>90

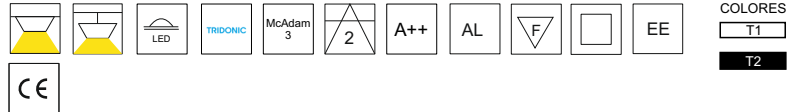

SISTEMAS DE REGULACIÓN:

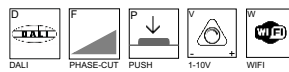

ACCESORIOS:

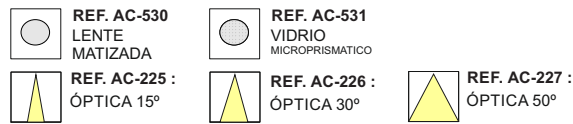

REF: AC 183
SUSPENSOR +ALIMENTACIÓN



REF: AC 404
ADAPTADOR A CARRIL



CILIM 60

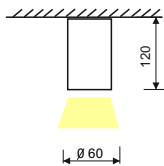

CÓDIGO

CÓDIGO	W	Lumen	K	CRI
LC-51172-SD-0-27	8	870	2700	>90
LC-51172-SD-0-30	8	970	3000	>90

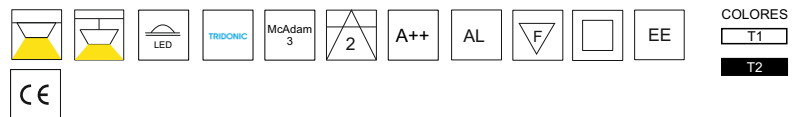

SISTEMAS DE REGULACIÓN:



ACCESORIOS:

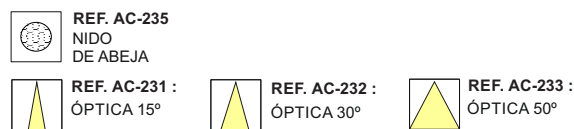

REF: AC 183
SUSPENSOR +ALIMENTACIÓN



REF: AC 404
ADAPTADOR A CARRIL



CUSTOMMADE



SURFACE LUMINARIES

LUZ&COLOR 2000

COVER 90

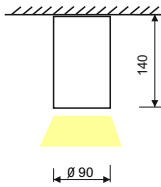

CÓDIGO

CÓDIGO	W	Lumen	K	CRI
LC-51140-SD-0-27	12	1700	2700	>90
LC-51140-SD-0-30	12	1800	3000	>90
LC-51140-SD-0-40	12	1900	4000	>90

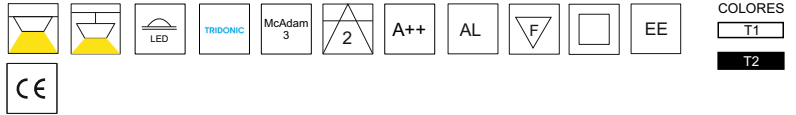

SISTEMAS DE REGULACIÓN:

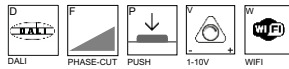

ACCESORIOS:

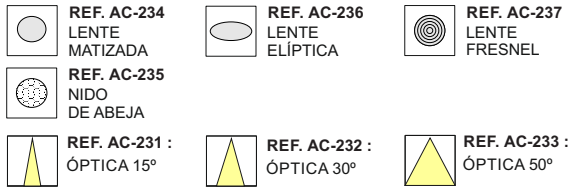

REF: AC 183
SUSPENSOR +ALIMENTACIÓN



REF: AC 404
ADAPTADOR A CARRIL

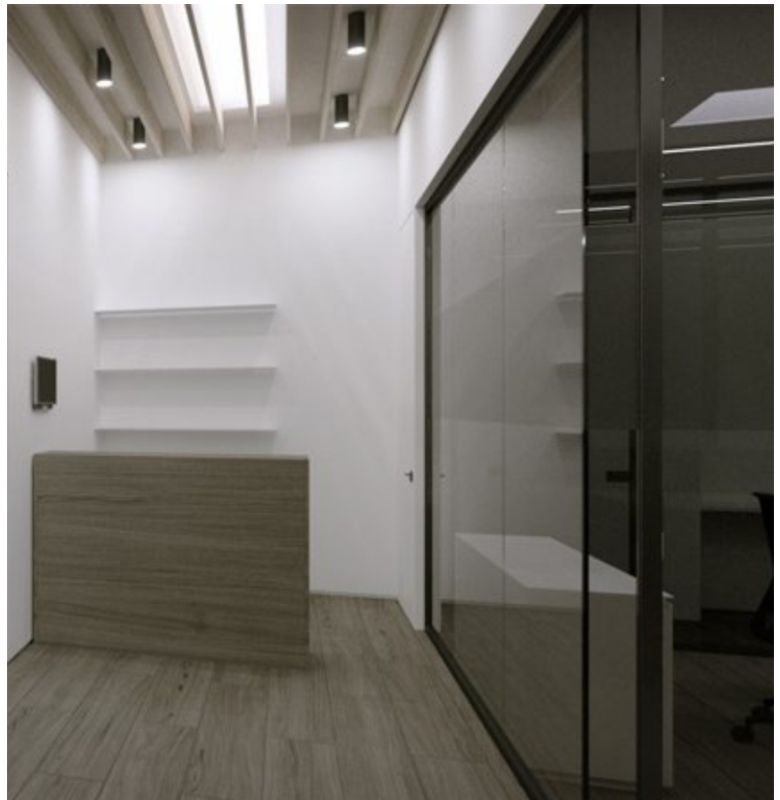
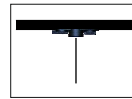



SERIE BLOCK 128



SURFACE LUMINARIES

LUZ&COLOR 2000

BLOCK 128 Simple

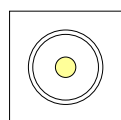
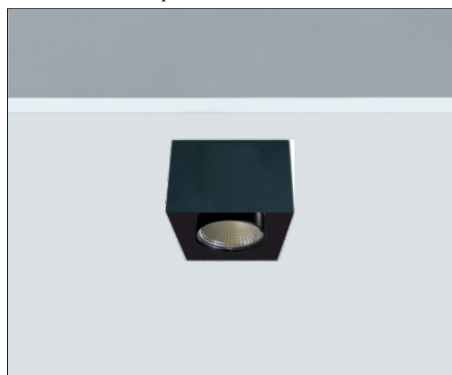

128

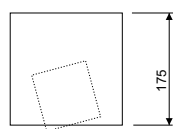

BLOCK 128 Doble

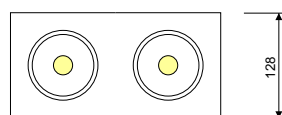

256



CÓDIGO W Lumen K CRI

LC-51010-SD-0-30	12	1700	2700	>90
LC-51010-SD-0-30	12	1800	3000	>90
LC-51010-SD-0-40	12	1900	4000	>90



SISTEMAS DE REGULACIÓN:

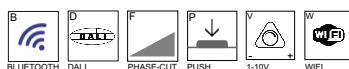

ACCESORIOS:

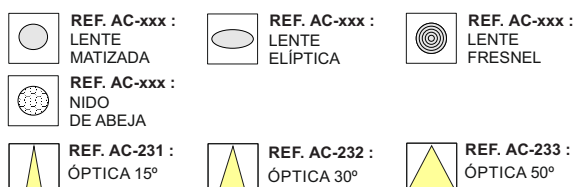

REF. AC 181
SUSPENSOR LINEAL



REF. AC 182
SUSPENSOR EN "Y"



REF. AC 183
SUSPENSOR +ALIMENTACIÓN



CÓDIGO W Lumen K CRI

LC-51015-DE-0-30	2x12	2x1700	2700	>90
LC-51015-DE-0-30	2x12	2x1800	3000	>90
LC-51015-DE-0-40	2x12	2x1900	4000	>90



SISTEMAS DE REGULACIÓN:

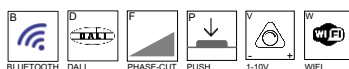

ACCESORIOS:

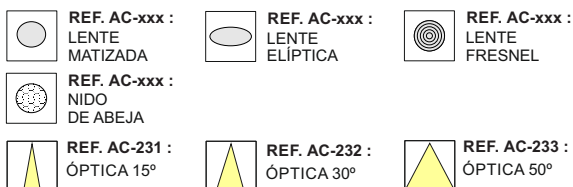

REF. AC 181
SUSPENSOR LINEAL



REF. AC 182
SUSPENSOR EN "Y"



REF. AC 183
SUSPENSOR +ALIMENTACIÓN



SURFACE LUMINARIES

LUZ&COLOR 2000

BK SQUARE 80 Doble

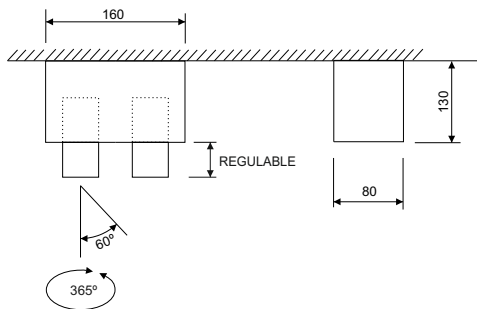

CÓDIGO

CÓDIGO	W	Lumen	K	CRI
LC-51161-SD-0-27	2x9	2x926	2700	95
LC-51161-SD-0-30	2x9	2x1050	3000	95

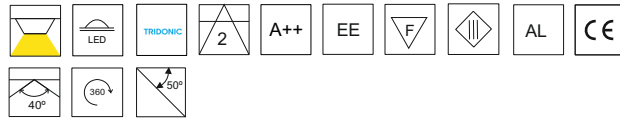

COLORES
01
02

SISTEMAS DE REGULACIÓN:

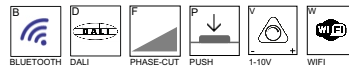

ACCESORIOS:



BK SQUARE 80 TRIPLE

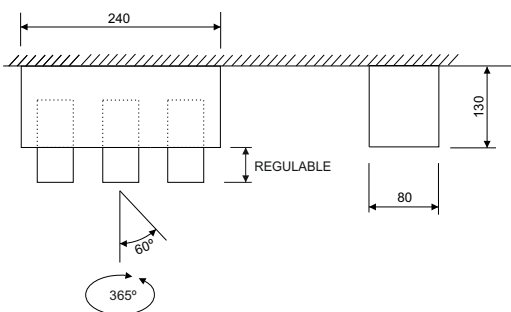

CÓDIGO

CÓDIGO	W	Lumen	K	CRI
LC-51162-SD-0-27	3x8	3x926	2700	95
LC-51162-SD-0-30	3x8	3x1050	3000	95

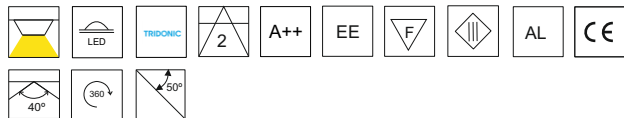

COLORES
01
02

SISTEMAS DE REGULACIÓN:

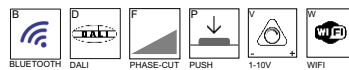

ACCESORIOS:



CUSTOMMADE

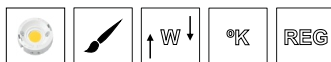

SURFACE LUMINARIES

LUZ&COLOR 2000

DEKO 1

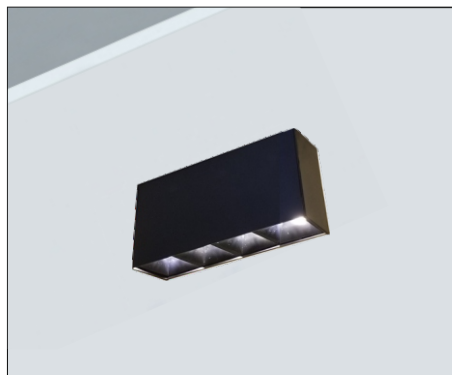

DEKO 1

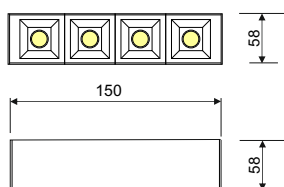

CÓDIGO	W	Lumen	K	CRI
--------	---	-------	---	-----

LC-51163-SD-0-27	7	1080	2700	>90
LC-51163-SD-0-30	7	1180	3000	>90

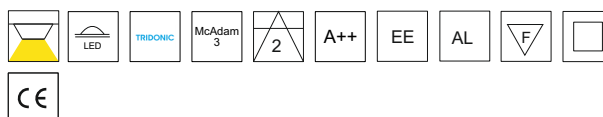

SISTEMAS DE REGULACIÓN:

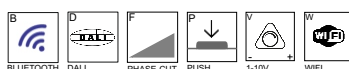

ACCESORIOS:



DEKO 2

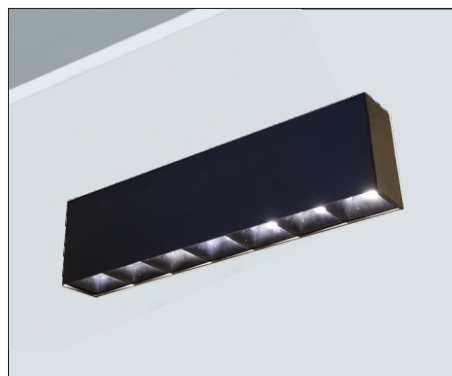

DEKO 2

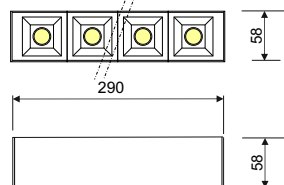

CÓDIGO	W	Lumen	K	CRI
--------	---	-------	---	-----

LC-51164-SD-0-27	17	2500	2700	>90
LC-51164-SD-0-30	17	2600	3000	>90

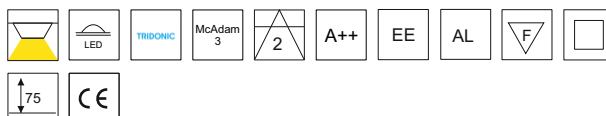

SISTEMAS DE REGULACIÓN:

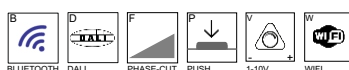

ACCESORIOS:





SURFACE LUMINARIES

LUZ&COLOR 2000

BOX 135
Luz directa/indirecta



CÓDIGO **W** **Lumen** **K** **CRI**

LC-51020-SD-0-00 "Según Lámpara 2xAR111"



COLORES
T1
T2

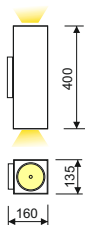

BOX 135
Luz directa

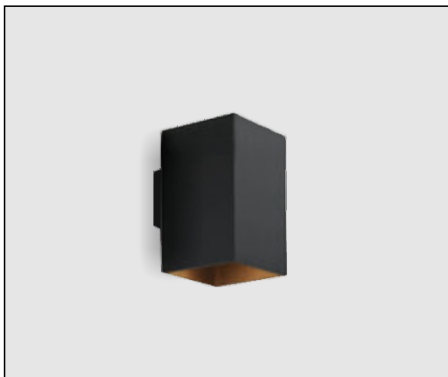

CODIGO **W** **Lumen** **K** **CRI**

LC-51025-SD-0-00 "Según Lámpara AR111"



COLORES
T1
T2

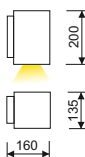

BOX 135
Techo

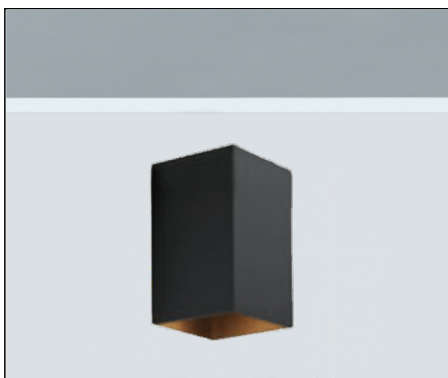

CÓDIGO **W** **Lumen** **K** **CRI**

LC-51030-SD-0-00 "Según Lámpara AR111"



COLORES
T1
T2

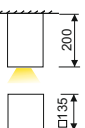

ACCESORIOS:

REF: AC 183
SUSPENSOR +ALIMENTACIÓN



REF: AC 404
ADAPTADOR A CARRIL



SURFACE LUMINARIES

LUZ&COLOR 2000

CILIM 120

Luz directa/indirecta



CÓDIGO

LC-51035-SD-0-00

W Lumen K CRI

"Según Lampara 2xAR111"

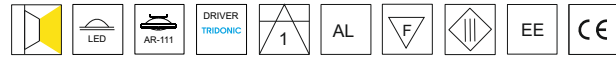

COLORES

T1

T2

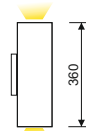

155

CILIM 120

Luz directa

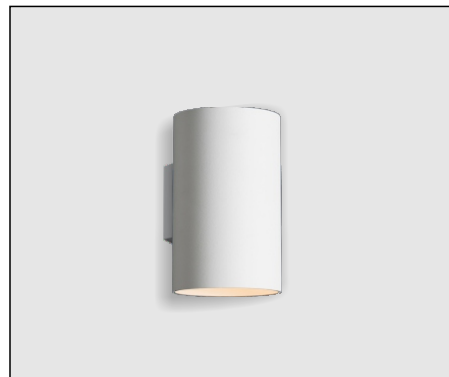

CÓDIGO

LC-51040-SD-0-00

W Lumen K CRI

"Según Lampara AR111"

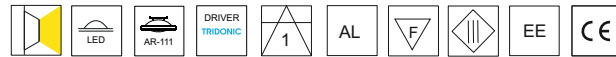

COLORES

T1

T2



155

CILIM 120

Techo

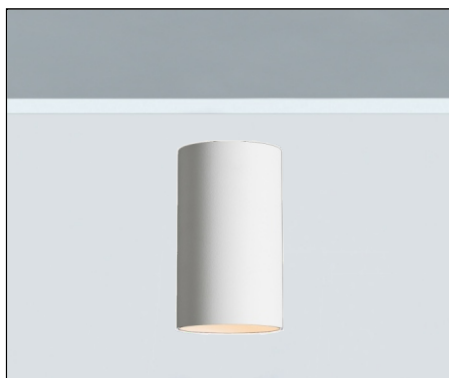

CÓDIGO

LC-51045-SD-0-00

W Lumen K CRI

"Según Lampara AR111"

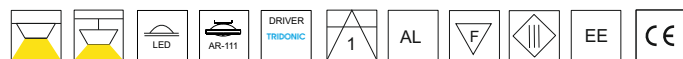

COLORES

T1

T2



120

ACCESORIOS:

REF: AC 183
SUSPENSOR +ALIMENTACIÓN



REF: AC 404
ADAPTADOR A CARRIL

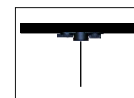

CUSTOMMADE



SURFACE LUMINARIES

BOX 90

Luz directa/indirecta



CÓDIGO

LC-51065-SD-0-00

W Lumen K CRI

"Según Lámpara 2xGU10"

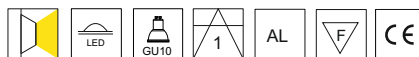

COLORES

T1

T2

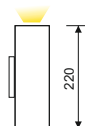

BOX 90

Luz directa

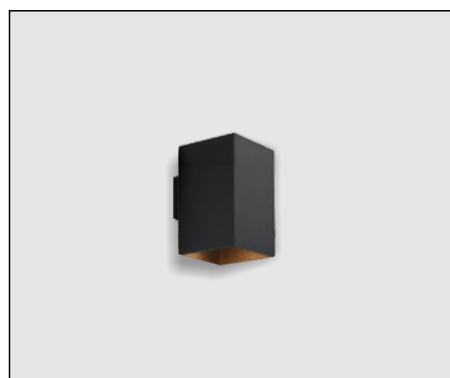

CÓDIGO

LC-51070-SD-0-00

W Lumen K CRI

"Según Lámpara GU10"

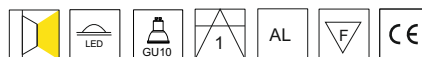

COLORES

T1

T2



BOX 90

Techo

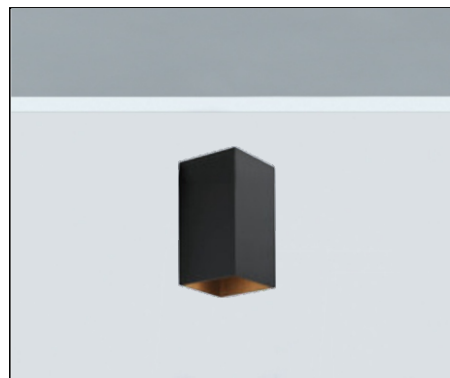

CÓDIGO

LC-51075-SD-0-00

W Lumen K CRI

"Según Lámpara GU10"



COLORES

T1

T2



ACCESORIOS:

REF: AC 183
SUSPENSOR + ALIMENTACIÓN



REF: AC 404
ADAPTADOR A CARRIL



SURFACE LUMINARIES

LUZ&COLOR 2000

CILIM 85

Luz directa/indirecta



CÓDIGO

LC-51050-SD-0-00

W Lumen K CRI

"Según Lampara 2xGU10"

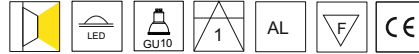

COLORES

T1

T2

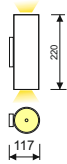

CILIM 85

Luz directa



CÓDIGO

LC-51055-SD-0-00

W Lumen K CRI

"Según Lampara GU10"

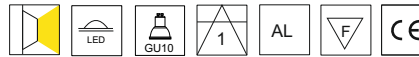

COLORES

T1

T2



CILIM 85

Techo

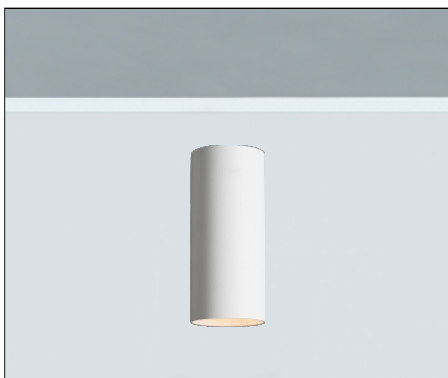

CÓDIGO

LC-51060-SD-0-00

W Lumen K CRI

"Según Lampara GU10"



COLORES

T1

T2

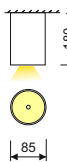

ACCESORIOS:

REF: AC 183
SUSPENSOR +ALIMENTACIÓN



REF: AC 404
ADAPTADOR A CARRIL



CUSTOMMADE



SURFACE LUMINARIES

LUZ&COLOR 2000

ECLIPSE

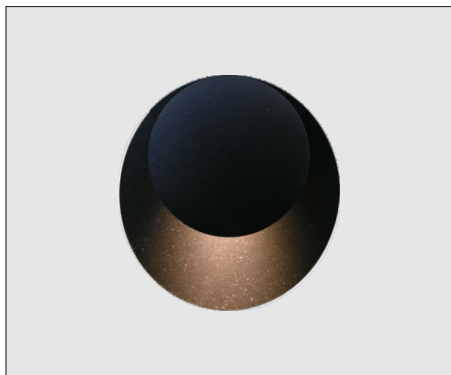

CÓDIGO	W	Lumen	K	CRI
LC-51130-SD-0-27	3	362	2700	>90
LC-51130-SD-0-30	3	374	3000	>90



COLORES

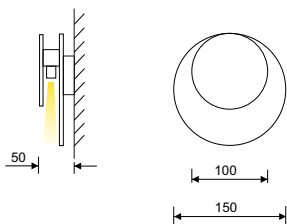

ACCESORIOS:



REF. AC-550 :
ÓPTICA 15°



REF. AC-551 :
ÓPTICA 30°



REF. AC-552 :
ÓPTICA 50°

POSIBILIDAD DE NUMERACIONES, CARACTERES O LOGOTIPOS

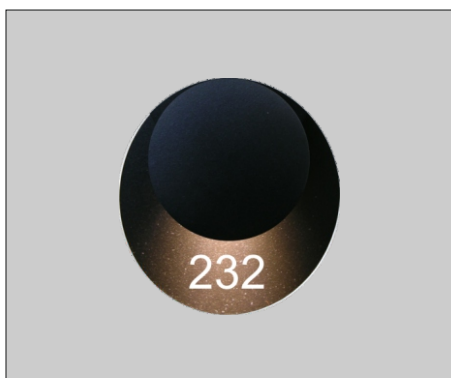

CUSTOMMADE



SURFACE LUMINARIES

LUZ&COLOR 2000

DINWALL



CÓDIGO	W	Lumen	K	CRI
LC-51085-SD-0-30	6,5	550	3000	>80

Technical specifications icons: LED, 2, A++, AL, F, EE, DP, CE, IP65. COLORES: T1, T7.

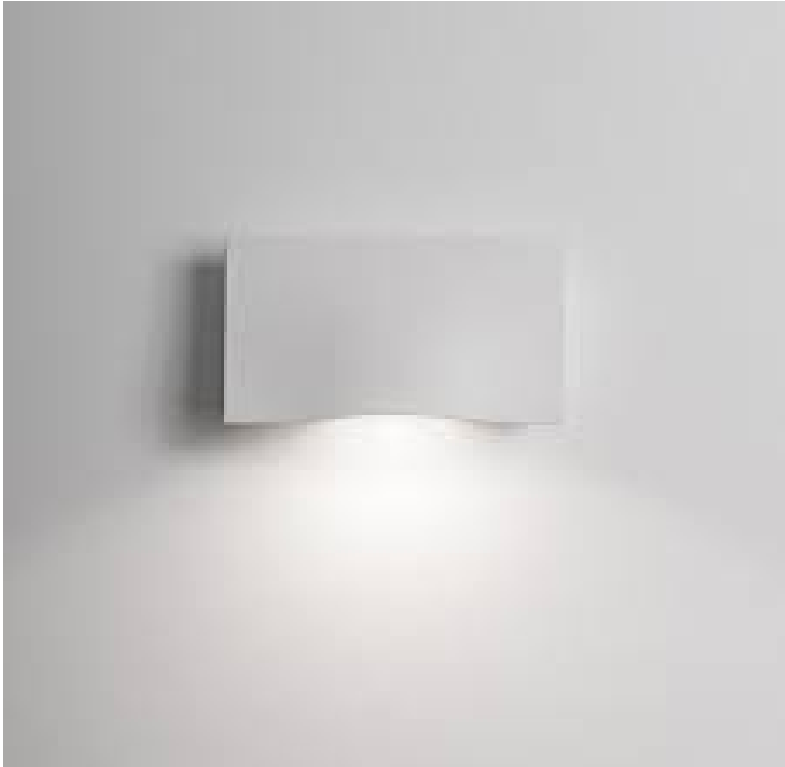
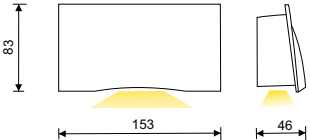

SURFACE LUMINARIES

LUZ&COLOR 2000

DOMME 170



CÓDIGO	W	Lumen	K	CRI	LONGITUD (mm)
LC-51165-SD-0-27	12	1700	2700	>90	280
LC-51165-SD-0-30	12	1800	3000	>90	280
AZ-51166-SD-0-30	12	1700	2700	>90	200
AZ-51166-SD-0-30	12	1800	3000	>90	200
AZ-51167-SD-0-30	12	1700	2700	>90	120
AZ-51167-SD-0-30	12	1800	3000	>90	120

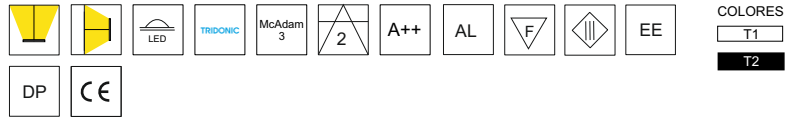

SISTEMAS DE REGULACIÓN (DRIVER REMOTO)

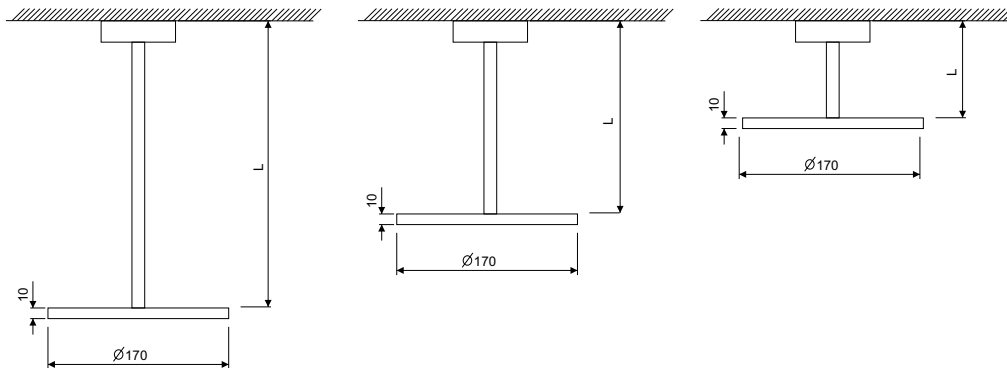
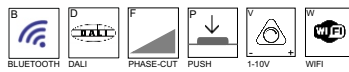

SURFACE LUMINARIES

LUZ&COLOR 2000

SEO Luz directa/indirecta

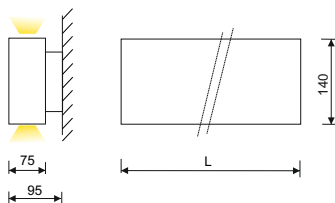
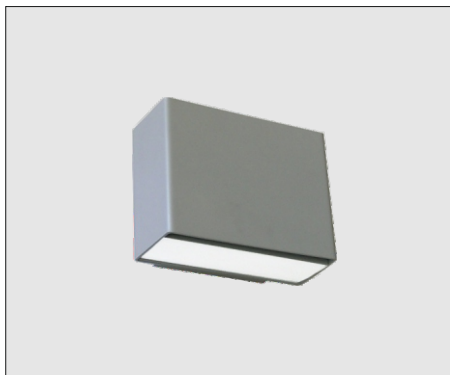

CÓDIGO	W	Lumen	K	CRI	LONGITUD(mm)
LC-51090-SD-0-30	2x6	2x870	3000	>80	155
LC-51090-SD-0-40	2x6	2x910	4000	>80	155
LC-51095-SD-0-30	2x12	2x1730	3000	>80	295
LC-51095-SD-0-40	2x12	2x1810	4000	>80	295
LC-51100-SD-0-30	2x23	2x3470	3000	>80	575
LC-51100-SD-0-40	2x23	2x3620	4000	>80	575

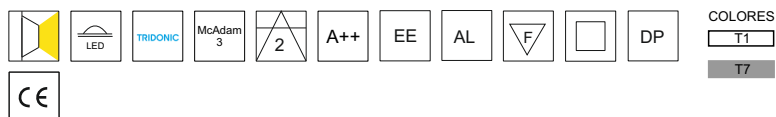

SISTEMAS DE REGULACIÓN:

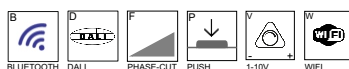

SEO Luz directa

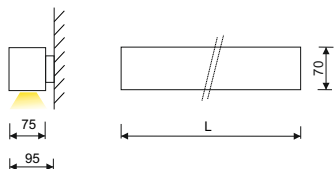

CÓDIGO	W	Lumen	K	CRI	LONGITUD(mm)
LC-51091-SD-0-30	6	870	3000	>80	155
LC-51091-SD-0-40	6	910	4000	>80	155
LC-51096-SD-0-30	12	1730	3000	>80	295
LC-51096-SD-0-40	12	1810	4000	>80	295
LC-51101-SD-0-30	23	3470	3000	>80	575
LC-51101-SD-0-40	23	3620	4000	>80	575

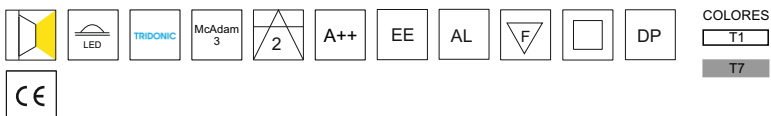

SISTEMAS DE REGULACIÓN:

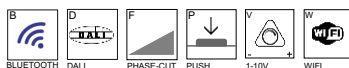

CUSTOMMADE



SUMER



SURFACE LUMINARIES

LUZ&COLOR 2000

SUMER 38



CÓDIGO	W	Lumen	K	CRI
LC-51110-SD-0-27	3	362	2700	>90
LC-51110-SD-0-30	3	374	3000	>90

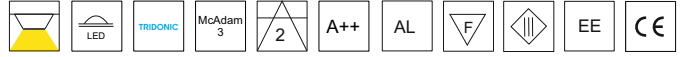

COLORES
T1
T2



ACCESORIOS:



REF: AC 183
SUSPENSOR +ALIMENTACIÓN



REF: AC 183
ADAPTADOR A CARRIL

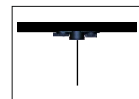

SISTEMAS DE REGULACIÓN (DRIVER REMOTO)

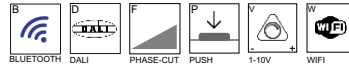

SUMER 50



CÓDIGO	W	Lumen	K	CRI
LC-51115-SD-0-27	8	926	2700	>90
LC-51115-SD-0-30	8	976	3000	>90
LC-51115-SD-0-40	8	1076	4000	>90

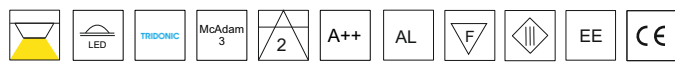

COLORES
T1
T2

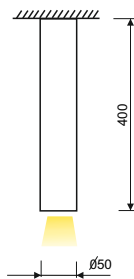

ACCESORIOS:



REF: AC 183
SUSPENSOR +ALIMENTACIÓN



REF: AC 183
ADAPTADOR A CARRIL

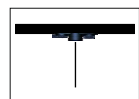

SISTEMAS DE REGULACIÓN (DRIVER REMOTO)

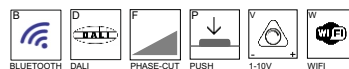

CUSTOMMADE   



SURFACE LUMINARIES

LUZ&COLOR 2000

MINISPOT-25 Vitrinas



CÓDIGO	W	Lumen	K	CRI
LC-51135-SD-0-27	3	362	2700	>90
LC-51135-SD-0-30	3	374	3000	>90

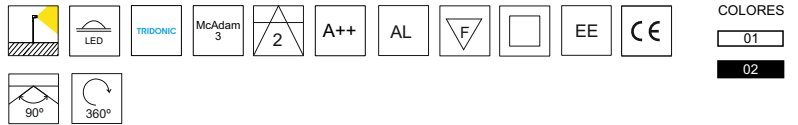

SISTEMAS DE REGULACIÓN (DRIVER REMOTO)

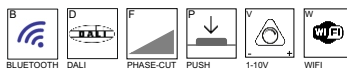

ACCESORIOS:

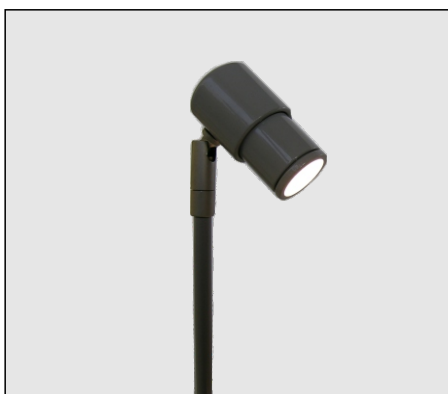
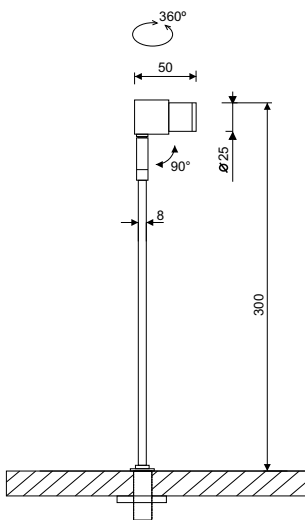

SURFACE LUMINARIES

LUZ&COLOR 2000

MINISPOT-25 Vitrinas

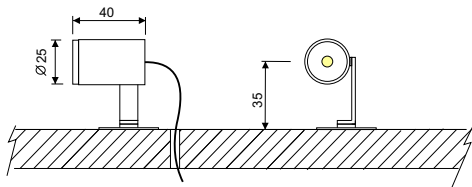

CÓDIGO	W	Lumen	K	CRI
--------	---	-------	---	-----

LC-20045-SD-0-27	3	362	2700	>90
LC-20045-SD-0-30	3	374	3000	>90

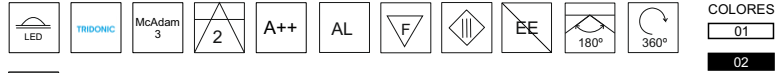

SISTEMAS DE REGULACIÓN (DRIVER REMOTO)

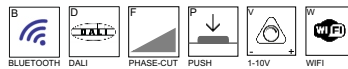

ACCESORIOS:



MINISPOT 35 Vitrinas

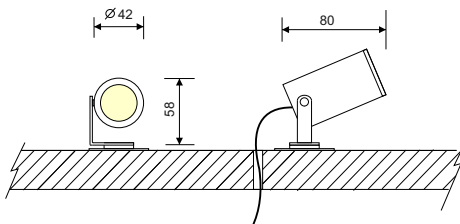

CÓDIGO	W	Lumen	K	CRI
--------	---	-------	---	-----

LC-20350-SD-0-27	8	926	2700	95
LC-20350-SD-0-30	8	976	3000	95
LC-20350-SD-0-40	8	1076	4000	95



SISTEMAS DE REGULACIÓN:

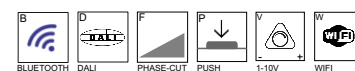

ACCESORIOS:

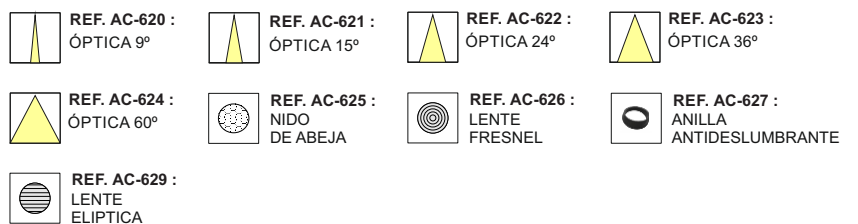

CUSTOMMADE



SURFACE LUMINARIES

STABILO Round Lectura

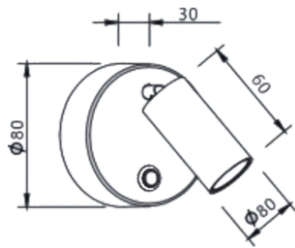

CÓDIGO	W	Lumen	K	CRI	°
LC-51170-SD-0-27	3	320	2700	95	25
LC-51170-SD-0-30	3	380	3000	95	25

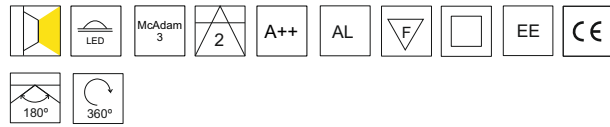

COLORES

01
02

STABILO Square Lectura

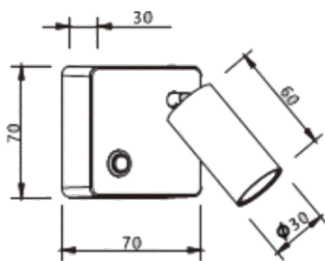

CÓDIGO	W	Lumen	K	CRI	°
AZ-120431-SD-0-27	3	320	2700	95	25
AZ-120431-SD-0-30	3	380	3000	95	25

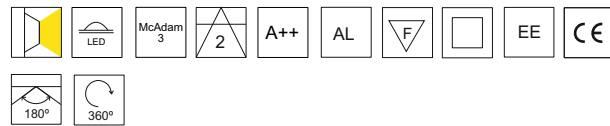

COLORES

01
02

SURFACE LUMINARIES

STABILO Square Lectura



CÓDIGO	W	Lumen	K	CRI	°
LC-51171-SD-0-27	3	320	2700	95	25
LC-51171-SD-0-30	3	380	3000	95	25

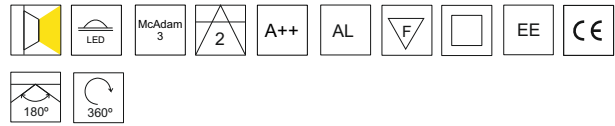

COLORES

01
02

